

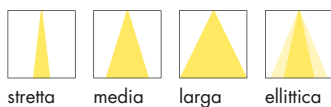

## INCASSI DOWNLIGHT DA INTERNO PER UFFICI E CONTESTI DI LAVORO



stretta media larga ellittica



2700K 3000K 4000K



### INCASSI

#### 1 OTTICA



**BITPOP 1.0** p. 532  
6,5W 24Vdc  
8W 230Vac  
ON/OFF, DALI, 0/1-10V

#### 2 OTTICHE ALLINEATE



**BITPOP 2.1** p. 533  
10W 230Vac  
15W 230Vac  
ON/OFF, DALI, 0/1-10V

#### 4 OTTICHE A MATRICE

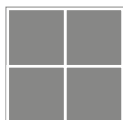

**BITPOP 2.2** p. 533  
18W 230Vac  
26W 230Vac  
ON/OFF, DALI, 0/1-10V

#### 4 OTTICHE ALLINEATE



**BITPOP 4.1** p. 534  
18W 230Vac  
26W 230Vac  
ON/OFF, DALI, 0/1-10V

#### 8 OTTICHE ALLINEATE



**BITPOP 8.1** p. 535  
35W 230Vac  
50W 230Vac  
ON/OFF, DALI, 0/1-10V

#### PLAFONIERE

**BITPOP C** p. 650

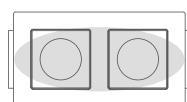
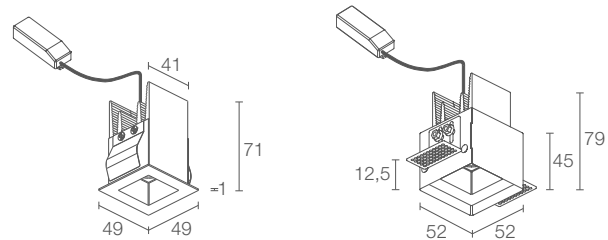

Ottica 17°x45°



Alimentatore incluso nella versione con alimentazione 230Vac  
Cassaforma per installazione arretrata non inclusa

## BITPOP 1.0

140x140 mm  
H 125 mm

43x43 mm



kg 0,26 IP40

A A+ A++ DALI PUSH 0/1-10V

### POTENZA / ALIMENTAZIONE CODICE

6,5W 24Vdc

**BP1000** W 0 Bianco - interno bianco  
**BP1000** B 0 Bianco - interno nero  
**BP1000** N 0 Nero - interno nero

8W 230Vac

**BP1010** W Bianco - interno bianco  
**BP1010** B Bianco - interno nero  
**BP1010** N Nero - interno nero

### COLORE LED

**1F** - 2700K CRI >90  
**15** - 3000K CRI >90  
**09** - 4000K CRI 80

### OTTICHE

**S** - 17°  
**F** - 30°  
**L** - 42°  
**W** - 17°x45°

### GESTIONE DI CONTROLLO

**O** - on/off  
**R** - 0/1-10V + PUSH  
**D** - DALI + PUSH

FLUSSO SORGENTE 480 lm (3000K)

FLUSSO EMESSO 335 lm (3000K, 30°)

NUMERO E TIPO LED 1 power LED High Intensity  
3 step MacAdam, 50000h L85 B10 (Ta 25°C)

MATERIALE corpo in alluminio anodizzato nero  
ghiera in acciaio

ALIMENTATORE 24Vdc: non incluso, vedi pag. 904  
230Vac: incluso e cablato

CAVI DI ALIMENTAZIONE 24Vdc: incluso cavo in PVC di 1,5 m  
FROR 2x0,35 Ø3,5 mm  
230Vac: incluso cavo di 0,30 m

MONTAGGIO a incasso (soffitto: in battuta o arretrato)

ACCESSORI vedi pag. 537

CARATTERISTICHE UGR < 10 per le ottiche 17° e 30°

NOTE versione plafoniera Bitpop C pag. 650  
su richiesta disponibile la versione con gestione  
Casambi, controllabile tramite app Casambi

DATI FOTOMETRICI vedi pag. 791

v

**BITPOP 2.2**  
3000K, 26W, 17°, bianco  
installazione in battuta

**BITPOP 2.2**  
3000K, 26W, 17°, bianco  
installazione arretrata con cassaforma

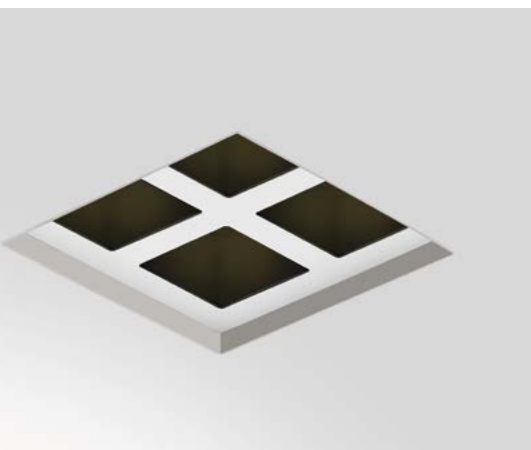
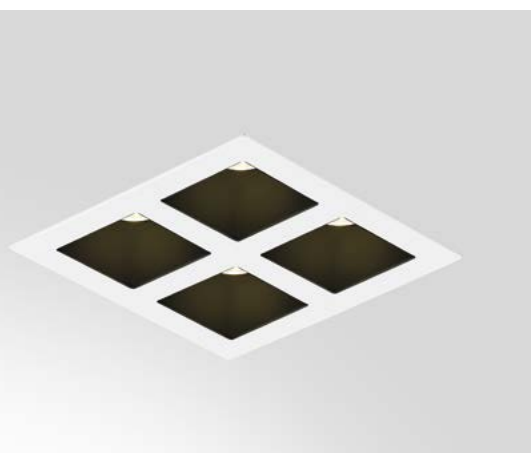

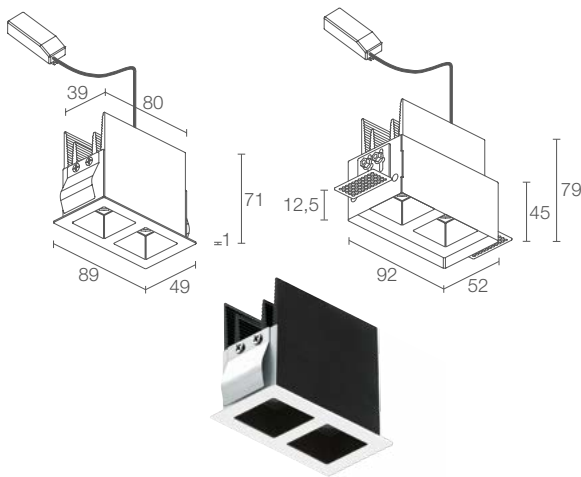

Cassaforma per installazione arretrata non inclusa

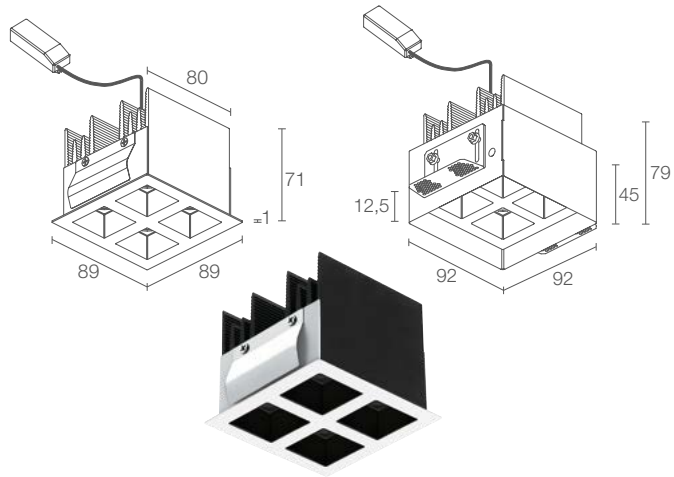

Cassaforma per installazione arretrata non inclusa

## BITPOP 2.1

170x90 mm  
H 130 mm

83x42 mm



kg 0,35 IP40

A A+ A++ DALI PUSH 0/1-10V

10W 230Vac

**BP2110** ■ **W** ■ Bianco - interno bianco  
**BP2110** ■ **B** ■ Bianco - interno nero  
**BP2110** ■ **N** ■ Nero - interno nero

15W 230Vac

**BP2111** ■ **W** ■ Bianco - interno bianco  
**BP2111** ■ **B** ■ Bianco - interno nero  
**BP2111** ■ **N** ■ Nero - interno nero

■ **1F** - 2700K CRI >90  
**15** - 3000K CRI >90  
**09** - 4000K CRI 80

■ **S** - 17°  
**F** - 30°  
**L** - 42°  
**W** - 17°x45°

■ **O** - on/off  
**R** - 0/1-10V + PUSH  
**D** - DALI

700 lm (3000K, 10W)  
960 lm (3000K, 15W)

496 lm (3000K, 30°, 10W)  
670 lm (3000K, 30°, 15W)

2 power LED High Intensity  
3 step MacAdam, 50000h L85 B10 (Ta 25°C)

corpo in alluminio anodizzato nero  
ghiera in acciaio

incluso e cablato

incluso cavo di 0,30 m

a incasso (soffitto: in battuta o arretrato)

vedi pag. 537

UGR < 10 per le ottiche 17° e 30°

versione plafoniera Bitpop C pag. 650  
su richiesta disponibile la versione con gestione  
Casambi, controllabile tramite app Casambi

vedi pag. 791

## BITPOP 2.2

170x170 mm  
H 130 mm

82x82 mm



kg 0,96 IP40

A A+ A++ DALI PUSH 0/1-10V

18W 230Vac

**BP2210** ■ **W** ■ Bianco - interno bianco  
**BP2210** ■ **B** ■ Bianco - interno nero  
**BP2210** ■ **N** ■ Nero - interno nero

26W 230Vac

**BP2211** ■ **W** ■ Bianco - interno bianco  
**BP2211** ■ **B** ■ Bianco - interno nero  
**BP2211** ■ **N** ■ Nero - interno nero

■ **1F** - 2700K CRI >90  
**15** - 3000K CRI >90  
**09** - 4000K CRI 80

■ **S** - 17°  
**F** - 30°  
**L** - 42°  
**W** - 17°x45°

■ **O** - on/off  
**R** - 0/1-10V + PUSH  
**D** - DALI + PUSH

1400 lm (3000K, 18W)  
1920 lm (3000K, 26W)

992 lm (3000K, 30°, 18W)  
1340 lm (3000K, 30°, 26W)

4 power LED High Intensity  
3 step MacAdam, 50000h L85 B10 (Ta 25°C)

corpo in alluminio anodizzato nero  
ghiera in acciaio

incluso e cablato

incluso cavo di 0,30 m

a incasso (soffitto: in battuta o arretrato)

vedi pag. 537

UGR < 10 per le ottiche 17° e 30°

versione plafoniera Bitpop C pag. 650  
su richiesta disponibile la versione con gestione  
Casambi, controllabile tramite app Casambi

vedi pag. 792

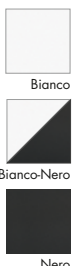

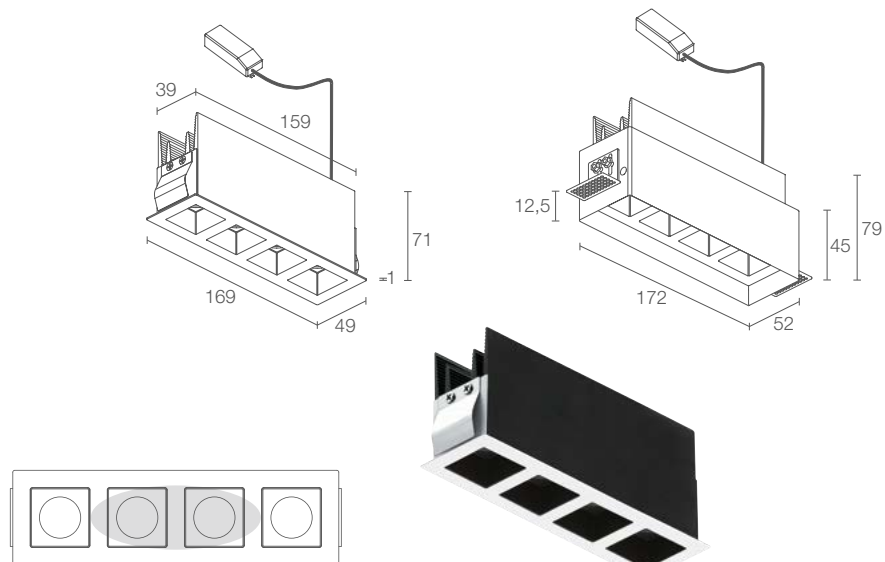

Ottica 17°x45°

Cassaforma per installazione arretrata non inclusa

## BITPOP 4.1

340x100 mm  
H 130 mm    162x42 mm



### POTENZA / ALIMENTAZIONE CODICE

18W 230Vac  
**BP4110** ■ ■ **W** ■ Bianco - interno bianco  
**BP4110** ■ ■ **B** ■ Bianco - interno nero  
**BP4110** ■ ■ **N** ■ Nero - interno nero

26W 230Vac  
**BP4111** ■ ■ **W** ■ Bianco - interno bianco  
**BP4111** ■ ■ **B** ■ Bianco - interno nero  
**BP4111** ■ ■ **N** ■ Nero - interno nero

<span style="color: orange;">■</span> <b>COLORE LED</b>	<b>1F</b> - 2700K CRI >90 <b>15</b> - 3000K CRI >90 <b>09</b> - 4000K CRI 80
<span style="color: grey;">■</span> <b>OTTICHE</b>	<b>S</b> - 17° <b>F</b> - 30° <b>L</b> - 42° <b>W</b> - 17°x45°
<span style="color: grey;">■</span> <b>GESTIONE DI CONTROLLO</b>	<b>O</b> - on/off <b>R</b> - 0/1-10V + PUSH <b>D</b> - DALI + PUSH

FLUSSO SORGENTE	1400 lm (3000K, 18W) 1920 lm (3000K, 26W)
FLUSSO EMESSO	992 lm (3000K, 30°, 18W) 1340 lm (3000K, 30°, 26W)
NUMERO E TIPO LED	4 power LED High Intensity 3 step MacAdam, 50000h L85 B10 (Ta 25°C)
MATERIALE	corpo in alluminio anodizzato nero ghiera in acciaio
ALIMENTATORE	incluso e cablato
CAVI DI ALIMENTAZIONE	incluso cavo di 0,30 m
MONTAGGIO	a incasso (soffitto: in battuta o arretrato)
ACCESSORI	vedi pag. 537
CARATTERISTICHE	UGR < 10 per le ottiche 17° e 30°
NOTE	versione plafoniera Bitpop C pag. 650 su richiesta disponibile la versione con gestione Casambi, controllabile tramite app Casambi
DATI FOTOMETRICI	vedi pag. 792

v

**BITPOP 4.1**  
3000K, 26W, 17°, bianco  
installazione in battuta

**BITPOP 4.1**  
3000K, 26W, 17°, bianco  
installazione arretrata con cassaforma



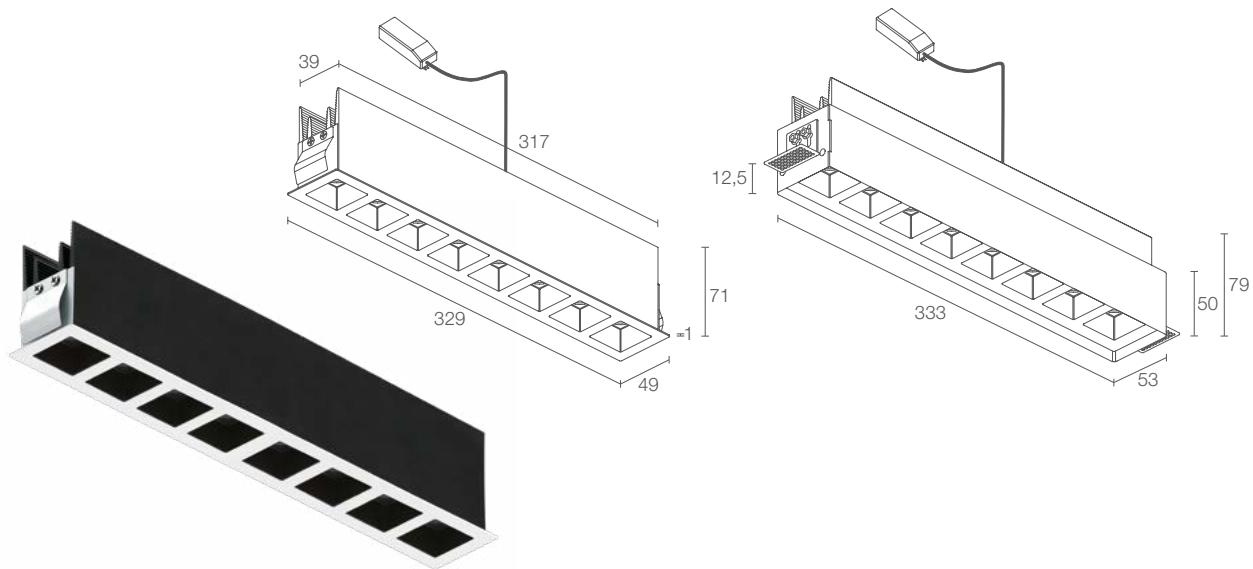

Cassaforma per installazione arretrata non inclusa

## BITPOP 8.1

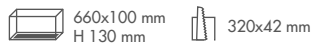

35W 230Vac

**BP8110** ■ **W** ■ Bianco - interno bianco  
**BP8110** ■ **B** ■ Bianco - interno nero  
**BP8110** ■ **N** ■ Nero - interno nero

50W 230Vac

**BP8111** ■ **W** ■ Bianco - interno bianco  
**BP8111** ■ **B** ■ Bianco - interno nero  
**BP8111** ■ **N** ■ Nero - interno nero

■ **1F** - 2700K CRI >90  
 ■ **15** - 3000K CRI >90  
 ■ **09** - 4000K CRI 80

■ **S** - 17°  
 ■ **F** - 30°  
 ■ **L** - 42°  
 ■ **W** - 17°x45°

■ **O** - on/off  
 ■ **R** - 0/1-10V + PUSH  
 ■ **D** - DALI + PUSH

2800 lm (3000K, 35W)  
 3840 lm (3000K, 50W)

1984 lm (3000K, 30°, 35W)  
 2680 lm (3000K, 30°, 50W)

8 power LED High Intensity  
 3 step MacAdam, 50000h L85 B10 (Ta 25°C)

corpo in alluminio anodizzato nero  
 ghiera in acciaio

incluso e cablato

incluso cavo di 0,30 m

a incasso (soffitto: in battuta o arretrato)

vedi pag. 537

UGR < 10 per le ottiche 17° e 30°

versione plafoniera Bitpop C pag. 650  
 su richiesta disponibile la versione con gestione  
 Casambi, controllabile tramite app Casambi

vedi pag. 792

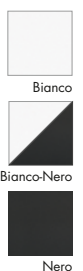



## ACCESSORI

### ACCESSORI PER INSTALLAZIONE

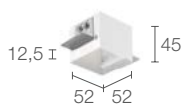

**WC8703** - Bianco  
**WC8703N** - Nero

Cassaforma per installazione arretrata su soffitto in cartongesso (Bitpop 1.0)

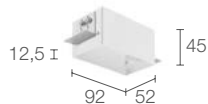

**WC8713** - Bianco  
**WC8713N** - Nero

Cassaforma per installazione arretrata su soffitto in cartongesso (Bitpop 2.1)



**WC8704** - Bianco  
**WC8704N** - Nero

Cassaforma per installazione arretrata su soffitto in cartongesso (Bitpop 2.2)

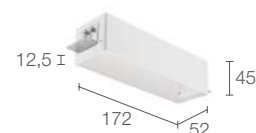

**WC8705** - Bianco  
**WC8705N** - Nero

Cassaforma per installazione arretrata su soffitto in cartongesso (Bitpop 4.1)

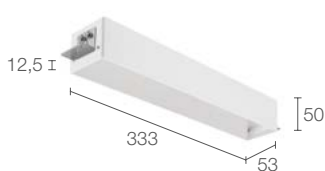

**WC8710** - Bianco  
**WC8710N** - Nero

Cassaforma per installazione arretrata su soffitto in cartongesso (Bitpop 8.1)

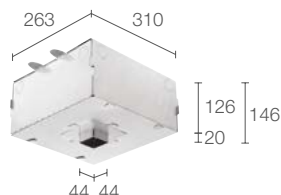

**WC8700**

Cassaforma per installazione in battuta su soffitto in muratura (Bitpop 1.0)

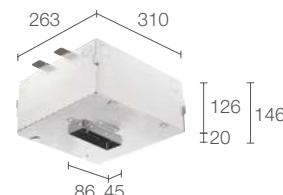

**WC8712**

Cassaforma per installazione in battuta su soffitto in muratura (Bitpop 2.1)

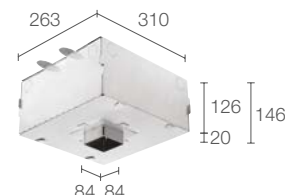

**WC8701**

Cassaforma per installazione in battuta su soffitto in muratura (Bitpop 2.2)

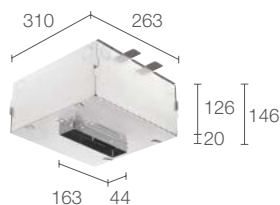

**WC8702**

Cassaforma per installazione in battuta su soffitto in muratura (Bitpop 4.1)

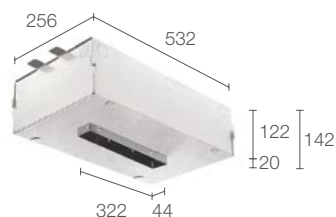

**WC8709**

Cassaforma per installazione in battuta su soffitto in muratura (Bitpop 8.1)





## INCASSI DA INTERNO

### BITPOP 1.0

#### S - 17°

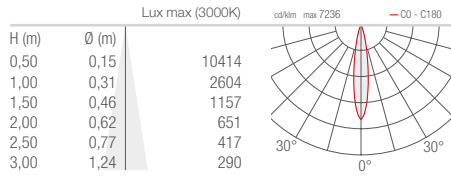

#### F - 30°

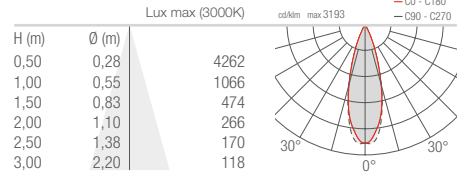

#### L - 42°

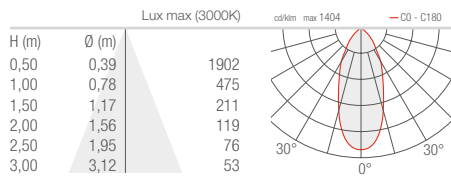

#### W - 17°x45°

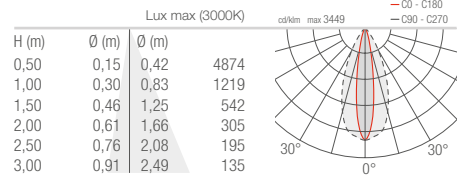

### BITPOP 2.1

#### S - 17°

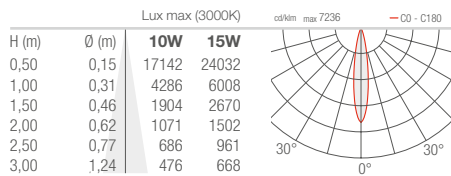

#### F - 30°

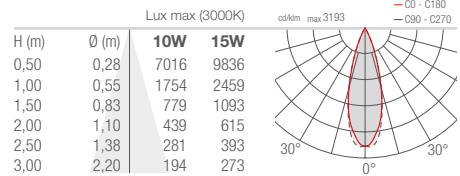

#### L - 42°

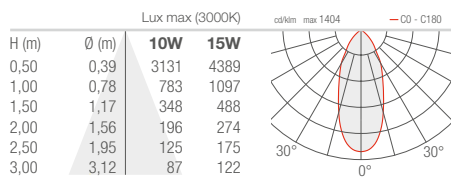

#### W - 17°x45°

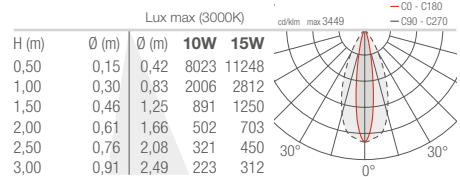

# BITPOP 2.2 4.1

## S - 17°

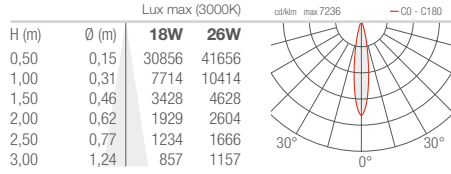

## F - 30°

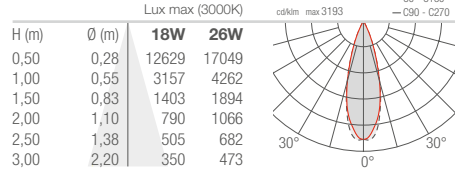

## L - 42°

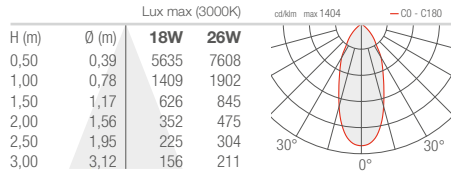

## W - 17°x45°

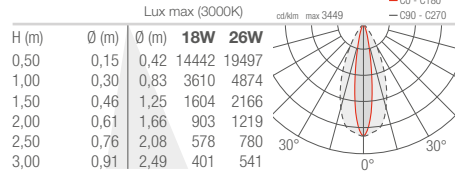

# BITPOP 8.1

## S - 17°

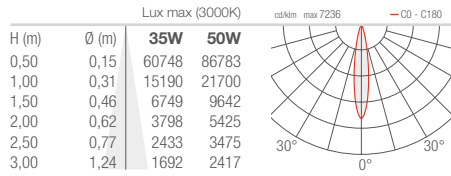

## F - 30°

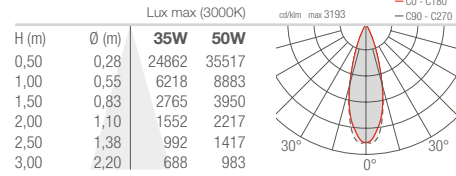

## L - 42°

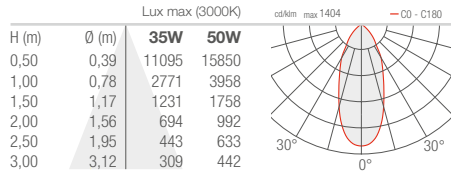

## W - 17°x45°

