



## PROFILI LINEARI DA INTERNO PER LINEE DI LUCE CONTINUA



diffusa microprismatizzata



2700K 3000K 4000K



**LARGHEZZA 42 mm**

**LARGHEZZA 70 mm**

### LUNGHEZZE STANDARD

562 mm  
842 mm  
1122 mm  
1682 mm  
2242 mm  
2802 mm



**BRENTA 1** p. 686  
19W/m 230Vac  
27W/m 230Vac



**BRENTA 2** p. 688  
27W/m 230Vac  
54W/m 230Vac

### LUNGHEZZE CUSTOM

5000 mm  
10000 mm  
15000 mm



**BRENTA 1 CUSTOM** p. 690  
19W/m 230Vac  
27W/m 230Vac



**BRENTA 2 CUSTOM** p. 690  
27W/m 230Vac  
54W/m 230Vac



**BRENTA 1**  
installazione a filo

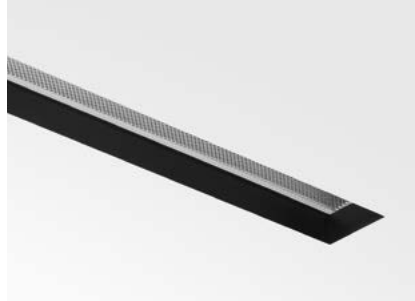

**BRENTA 1**  
installazione arretrata

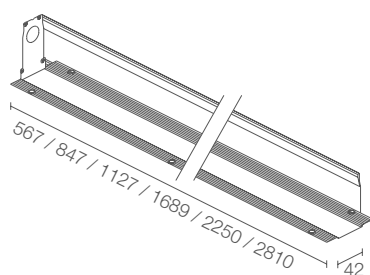

## BRENTA 1

Cassaforma non inclusa obbligatoria  
Schermo non incluso obbligatorio

CE ENEC LED TECH a filo kg/m 2,26 arretrato kg/m 2,40 IP40 A A+ A++ DALI

ALIMENTAZIONE	230Vac	
POTENZE	<b>19W/m</b> 11W (562 mm) 16W (842 mm) 22W (1122 mm) 33W (1682 mm) 43W (2242 mm) 54W (2802 mm)	<b>27W/m</b> 15W (562 mm) 23W (842 mm) 30W (1122 mm) 46W (1682 mm) 61W (2242 mm) 76W (2802 mm)
FLUSSO SORGENTE	<b>19W/m, 3000K</b> 1780 lm/m	<b>27W/m, 3000K</b> 2500 lm/m
FLUSSO EMESSO	<b>19W/m, 3000K, ottica diffusa</b> 1100 lm/m (installazione a filo) 750 lm/m (installazione arretrata) <b>19W/m, 3000K, ottica microprismatizzata</b> 1000 lm/m (installazione a filo) 800 lm/m (installazione arretrata)	<b>27W/m, 3000K, ottica diffusa</b> 1550 lm/m (installazione a filo) 1050 lm/m (installazione arretrata) <b>27W/m, 3000K, ottica microprismatizzata</b> 1400 lm/m (installazione a filo) 1100 lm/m (installazione arretrata)
NUMERO E TIPO LED	48 mid power LED (562 mm) 3 step MacAdam, 50000h L90 B10 (Ta 25°C) 72 mid power LED (842 mm) 3 step MacAdam, 50000h L90 B10 (Ta 25°C) 96 mid power LED (1122 mm) 3 step MacAdam, 50000h L90 B10 (Ta 25°C) 144 mid power LED (1682 mm) 3 step MacAdam, 50000h L90 B10 (Ta 25°C) 192 mid power LED (2242 mm) 3 step MacAdam, 50000h L90 B10 (Ta 25°C) 240 mid power LED (2802 mm) 3 step MacAdam, 50000h L90 B10 (Ta 25°C)	
MATERIALE	corpo in alluminio schermo in policarbonato opalino (versione diffusa) schermo in policarbonato microprismatizzato (versione microprismatizzata)	
ALIMENTATORE	integrato	
CAVI DI ALIMENTAZIONE	morsettiera	
MONTAGGIO	a incasso (soffitto, parete)	
CARATTERISTICHE	CRI >90	
NOTE	Brenta Custom, vedi pag. 690 su richiesta disponibile la versione con gestione Casambi, controllabile tramite app Casambi	
DATI FOTOMETRICI	vedi pag. 795	

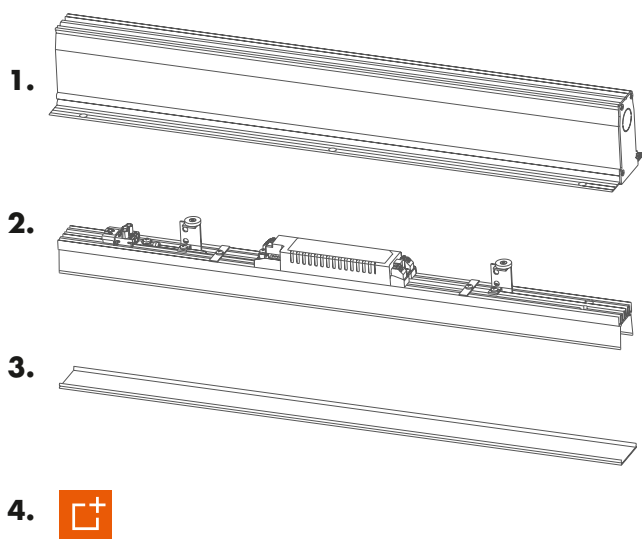

1. CASSAFORMA	2. APPARECCHIO ILLUMINANTE	3. SCHERMO	4. ACCESSORI
<p><b>WCBR11F</b> - 567 mm  <b>WCBR12F</b> - 847 mm  <b>WCBR13F</b> - 1127 mm  <b>WCBR15F</b> - 1689 mm  <b>WCBR17F</b> - 2250 mm  <b>WCBR19F</b> - 2810 mm</p> <p>Cassaforma per <b>installazione a filo</b> h 80 mm</p> <p><b>WCBR11A</b> - 567 mm  <b>WCBR12A</b> - 847 mm  <b>WCBR13A</b> - 1127 mm  <b>WCBR15A</b> - 1689 mm  <b>WCBR17A</b> - 2250 mm  <b>WCBR19A</b> - 2810 mm</p> <p>Cassaforma nera per <b>installazione arretrata</b> h 95 mm</p> <p><b>WCBR190PF</b> - installazione a filo  <b>WCBR190PA</b> - installazione arretrata</p> <p>Cassaforma ad angolo su piano orizzontale 588x620 mm</p> <p><b>WCBR190SF</b> - installazione a filo  <b>WCBR190SA</b> - installazione arretrata</p> <p>Cassaforma ad angolo su piano verticale 644x644 mm</p>	<p><b>CODICE</b>            DALI 27W/m  <b>BR1</b> ■ 111 ■ OBD</p> <p>ON/OFF  <b>BR1</b> ■ 1 ■ 1 ■ OBO</p> <hr/> <p>■ <b>LUNGHEZZA</b>  <b>1</b> - 562 mm  <b>2</b> - 842 mm  <b>3</b> - 1122 mm  <b>5</b> - 1682 mm  <b>7</b> - 2242 mm  <b>9</b> - 2802 mm</p> <p>■ <b>POTENZA</b>  <b>0</b> - 19W/m  <b>1</b> - 27W/m</p> <p>■ <b>COLORE LED</b>  <b>F</b> - 2700K  <b>5</b> - 3000K  <b>9</b> - 4000K</p>	<p><b>WRBR11D</b> - 563 mm  <b>WRBR12D</b> - 843 mm  <b>WRBR13D</b> - 1123 mm  <b>WRBR15D</b> - 1685 mm  <b>WRBR17D</b> - 2246 mm  <b>WRBR19D</b> - 2806 mm</p> <p>Ottica diffusa</p> <p><b>WRBR11P</b> - 563 mm  <b>WRBR12P</b> - 843 mm  <b>WRBR13P</b> - 1123 mm  <b>WRBR15P</b> - 1685 mm  <b>WRBR17P</b> - 2246 mm  <b>WRBR19P</b> - 2806 mm</p> <p>Ottica microprismatizzata</p>	<p><b>WABR101A</b>            Kit di allineamento per cassaforme</p> <p><b>WF0321</b>            Connettore femmina a 5 poli</p> <p><b>WUBR1000</b>            Kit antifuga</p> <p><b>WNB001A</b>            Kit anticaduta per cassaforme:            WCBR15F, WCBR15A            WCBR17F, WCBR17A            WCBR19F, WCBR19A</p> <p>per ricambi vedi pag. 932</p>

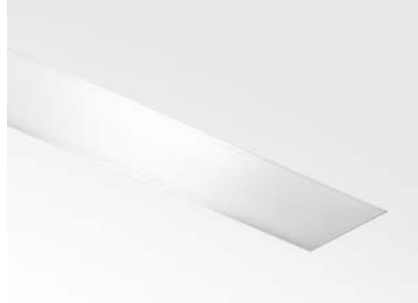

^  
**BRENTA 2**  
installazione a filo

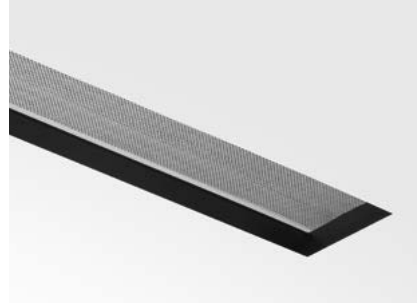

^  
**BRENTA 2**  
installazione arretrata

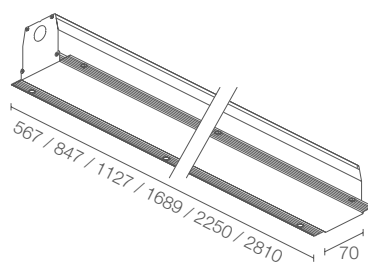

## BRENTA 2

Cassaforma non inclusa obbligatoria  
Schermo non incluso obbligatorio

CE ENEC LED TECH a filo kg/m 3,25 arretrato kg/m 3,38 IP40 A A+ A++ DALI

ALIMENTAZIONE	230Vac	
POTENZE	<b>27W/m</b> 15W (562 mm) 23W (842 mm) 30W (1122 mm) 46W (1682 mm) 61W (2242 mm) 76W (2802 mm)	<b>54W/m</b> 30W (562 mm) 46W (842 mm) 61W (1122 mm) 91W (1682 mm) 122W (2242 mm) 126W (2802 mm)
FLUSSO SORGENTE	<b>27W/m, 3000K</b> 2500 lm/m	<b>54W/m, 3000K</b> 5000 lm/m
FLUSSO EMESSO	<b>27W/m, 3000K, ottica diffusa</b> 1550 lm/m (installazione a filo) 1200 lm/m (installazione arretrata) <b>27W/m, 3000K, ottica microprismatizzata</b> 1500 lm/m (installazione a filo) 1350 lm/m (installazione arretrata)	<b>54W/m, 3000K, ottica diffusa</b> 3100 lm/m (installazione a filo) 2450 lm/m (installazione arretrata) <b>54W/m, 3000K, ottica microprismatizzata</b> 3000 lm/m (installazione a filo) 2700 lm/m (installazione arretrata)
NUMERO E TIPO LED	96 mid power LED (562 mm) 3 step MacAdam, 50000h L90 B10 (Ta 25°C) 144 mid power LED (842 mm) 3 step MacAdam, 50000h L90 B10 (Ta 25°C) 192 mid power LED (1122 mm) 3 step MacAdam, 50000h L90 B10 (Ta 25°C) 288 mid power LED (1682 mm) 3 step MacAdam, 50000h L90 B10 (Ta 25°C) 384 mid power LED (2242 mm) 3 step MacAdam, 50000h L90 B10 (Ta 25°C) 480 mid power LED (2802 mm) 3 step MacAdam, 50000h L90 B10 (Ta 25°C)	
MATERIALE	corpo in alluminio schermo in policarbonato opalino (versione diffusa) schermo in policarbonato microprismatizzato (versione microprismatizzata)	
ALIMENTATORE	integrato	
CAVI DI ALIMENTAZIONE	morsettiera	
MONTAGGIO	a incasso (soffitto, parete)	
CARATTERISTICHE	CRI >90	
NOTE	Brenta Custom, vedi pag. 690 su richiesta disponibile la versione con gestione Casambi, controllabile tramite app Casambi	
DATI FOTOMETRICI	vedi pag. 795	

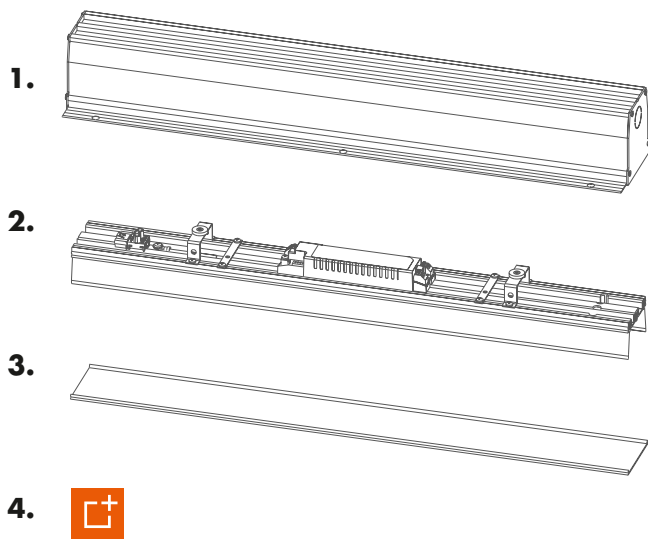

1. CASSAFORMA	2. APPARECCHIO ILLUMINANTE	3. SCHERMO	4. ACCESSORI
<p><b>WCBR21F</b> - 567 mm  <b>WCBR22F</b> - 847 mm  <b>WCBR23F</b> - 1127 mm  <b>WCBR25F</b> - 1689 mm  <b>WCBR27F</b> - 2250 mm  <b>WCBR29F</b> - 2810 mm</p> <p>Cassaforma per <b>installazione a filo</b> h 76 mm</p> <p><b>WCBR21A</b> - 567 mm  <b>WCBR22A</b> - 847 mm  <b>WCBR23A</b> - 1127 mm  <b>WCBR25A</b> - 1689 mm  <b>WCBR27A</b> - 2250 mm  <b>WCBR29A</b> - 2810 mm</p> <p>Cassaforma nera per <b>installazione arretrata</b> h 91 mm</p> <p><b>WCBR290PF</b> - installazione a filo  <b>WCBR290PA</b> - installazione arretrata</p> <p>Cassaforma ad angolo su piano orizzontale 588x648 mm</p> <p><b>WCBR290SF</b> - installazione a filo  <b>WCBR290SA</b> - installazione arretrata</p> <p>Cassaforma ad angolo su piano verticale 634x634 mm</p>	<p><b>CODICE</b>            DALI 54W/m  <b>BR2</b> ■ 111 ■ OBD</p> <p>ON/OFF  <b>BR2</b> ■ 1 ■ 1 ■ OBO</p> <p>■ <b>LUNGHEZZA</b>  <b>1</b> - 562 mm  <b>2</b> - 842 mm  <b>3</b> - 1122 mm  <b>5</b> - 1682 mm  <b>7</b> - 2242 mm  <b>9</b> - 2802 mm</p> <p>■ <b>POTENZA</b>  <b>0</b> - 27W/m  <b>1</b> - 54W/m</p> <p>■ <b>COLORE LED</b>  <b>F</b> - 2700K  <b>5</b> - 3000K  <b>9</b> - 4000K</p>	<p><b>WRBR21D</b> - 563 mm  <b>WRBR22D</b> - 843 mm  <b>WRBR23D</b> - 1123 mm  <b>WRBR25D</b> - 1685 mm  <b>WRBR27D</b> - 2246 mm  <b>WRBR29D</b> - 2806 mm</p> <p>Ottica diffusa</p> <p><b>WRBR21P</b> - 563 mm  <b>WRBR22P</b> - 843 mm  <b>WRBR23P</b> - 1123 mm  <b>WRBR25P</b> - 1685 mm  <b>WRBR27P</b> - 2246 mm  <b>WRBR29P</b> - 2806 mm</p> <p>Ottica microprismatizzata</p>	<p><b>WHBR2000</b>            Nido d'ape            versione 562 mm:            4 pezzi nido d'ape            versione 842 mm:            6 pezzi nido d'ape            versione 1122 mm:            8 pezzi nido d'ape            versione 1682 mm:            12 pezzi nido d'ape            versione 2242 mm:            16 pezzi nido d'ape            versione 2802 mm:            20 pezzi nido d'ape</p> <p>Il nido d'ape è applicabile sull'ottica diffusa e con cassaforma per installazione arretrata</p> <p><b>WABR201A</b>            Kit di allineamento per cassaforme</p> <p><b>WF0321</b>            Connettore femmina a 5 poli</p> <p><b>WUBR2000</b>            Kit antifuga</p> <p><b>WNB001A</b>            Kit anticaduta per cassaforme:            WCBR25F, WCBR25A            WCBR27F, WCBR27A            WCBR29F, WCBR29A</p> <p>per ricambi vedi pag. 932</p>

# BRENTA CUSTOM

## COSTRUISCI BRENTA NELLA LUNGHEZZA CHE DESIDERI

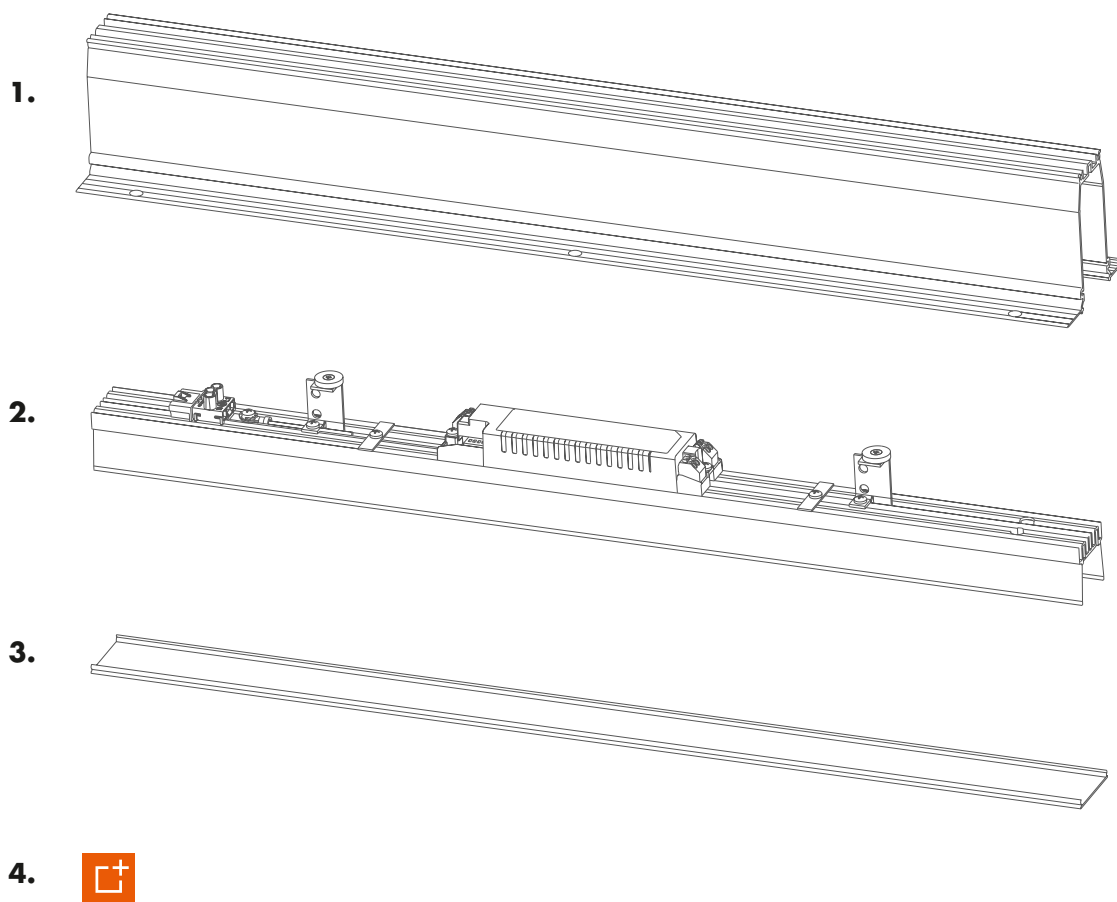



**BRENTA 1**  
3000K, 19W/m, ottica diffusa  
installazione a filo soffitto



1. CASSAFORMA	BRENTA 1	BRENTA 2
<p>Cassaforma per <b>installazione a filo</b> vedi cassaforme standard a pag. 687 e 689 per eventuale completamento della lunghezza desiderata</p> <p>Cassaforma nera per <b>installazione arretrata</b> vedi cassaforme standard a pag. 687 e 689 per eventuale completamento della lunghezza desiderata</p> <p>Cassaforma non inclusa obbligatoria</p>	<p><b>WCBR17FC</b> 2247 mm</p> <p><b>WCBR19FC</b> 2807 mm h 80 mm</p> <p><b>WCBR17AC</b> 2247 mm</p> <p><b>WCBR19AC</b> 2807 mm h 95 mm</p>	<p><b>WCBR27FC</b> 2247 mm</p> <p><b>WCBR29FC</b> 2807 mm h 76 mm</p> <p><b>WCBR27AC</b> 2247 mm</p> <p><b>WCBR29AC</b> 2807 mm h 91 mm</p>
<p><b>2. APPARECCHIO ILLUMINANTE</b></p>	<p><b>CODICE</b> DALI 27W/m <b>BR1</b> ■ 111 ■ <b>OBD</b> ON/OFF <b>BR1</b> ■ 1 ■ 1 ■ <b>OBO</b></p> <hr/> <p>■ <b>LUNGHEZZA</b> 1 - 562 mm 2 - 842 mm 3 - 1122 mm 5 - 1682 mm 7 - 2242 mm 9 - 2802 mm</p> <p>■ <b>POTENZA</b> 0 - 19W/m 1 - 27W/m</p> <p>■ <b>COLORE LED</b> F - 2700K 5 - 3000K 9 - 4000K</p>	<p><b>CODICE</b> DALI 54W/m <b>BR2</b> ■ 111 ■ <b>OBD</b> ON/OFF <b>BR2</b> ■ 1 ■ 1 ■ <b>OBO</b></p> <hr/> <p>■ <b>LUNGHEZZA</b> 1 - 562 mm 2 - 842 mm 3 - 1122 mm 5 - 1682 mm 7 - 2242 mm 9 - 2802 mm</p> <p>■ <b>POTENZA</b> 0 - 27W/m 1 - 54W/m</p> <p>■ <b>COLORE LED</b> F - 2700K 5 - 3000K 9 - 4000K</p>
<p><b>3. SCHERMO</b></p> <p>Ottica diffusa</p> <p>Ottica microprismatizzata</p> <p>Schermo non incluso obbligatorio</p>	<p><b>WRBR105D</b> 5000 mm</p> <p><b>WRBR110D</b> 10000 mm</p> <p><b>WRBR115D</b> 15000 mm</p> <p><b>WRBR105P</b> 5000 mm</p> <p><b>WRBR110P</b> 10000 mm</p> <p><b>WRBR115P</b> 15000 mm</p>	<p><b>WRBR205D</b> 5000 mm</p> <p><b>WRBR210D</b> 10000 mm</p> <p><b>WRBR215D</b> 15000 mm</p> <p><b>WRBR205P</b> 5000 mm</p> <p><b>WRBR210P</b> 10000 mm</p> <p><b>WRBR215P</b> 15000 mm</p>

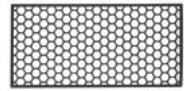

# COSTRUISCI BRENTA NELLA LUNGHEZZA CHE DESIDERI

4. ACCESSORI	BRENTA 1	BRENTA 2
<p><b>ACCESSORI PER INSTALLAZIONE AD ANGOLO</b></p>  <p>Cassaforma ad angolo su piano orizzontale</p>  <p>Cassaforma ad angolo su piano verticale</p>	<p><b>WCBR190PF</b> Installazione a filo</p> <p><b>WCBR190PA</b> Installazione arretrata 588x620 mm</p> <p><b>WCBR190SF</b> Installazione a filo</p> <p><b>WCBR190SA</b> Installazione arretrata 644x644 mm</p>	<p><b>WCBR290PF</b> Installazione a filo</p> <p><b>WCBR290PA</b> Installazione arretrata 588x648 mm</p> <p><b>WCBR290SF</b> Installazione a filo</p> <p><b>WCBR290SA</b> Installazione arretrata 634x634 mm</p>
<p><b>ACCESSORI PER INSTALLAZIONE</b></p> <p>Kit di allineamento per cassaforme</p> <p>Connettori</p> <p>Coppia di testate per cassaforma</p> <p>Coppia di estrattori per cassaforme</p> <p>Kit antifuga</p> <p>Kit anticaduta</p>	<p><b>WABR101A</b></p> <p><b>WF0320</b> Connettore femmina a 3 poli</p> <p><b>WF0321</b> Connettore femmina a 5 poli</p> <p><b>WABR100F</b> Installazione a filo</p> <p><b>WABR100A</b> Installazione arretrata</p> <p><b>WNB000A</b></p> <p><b>WUBR1000</b></p> <p><b>WNB001A</b> per cassaforme: WCBR15F, WCBR15A WCBR17F, WCBR17A WCBR19F, WCBR19A WCBR17FC, WCBR17AC WCBR19FC, WCBR19AC</p>	<p><b>WABR201A</b></p> <p><b>WF0320</b> Connettore femmina a 3 poli</p> <p><b>WF0321</b> Connettore femmina a 5 poli</p> <p><b>WABR200F</b> Installazione a filo</p> <p><b>WABR200A</b> Installazione arretrata</p> <p><b>WNB000A</b></p> <p><b>WUBR2000</b></p> <p><b>WNB001A</b> per cassaforme: WCBR25F, WCBR25A WCBR27F, WCBR27A WCBR29F, WCBR29A WCBR27FC, WCBR27AC WCBR29FC, WCBR29AC</p>
<p><b>ACCESSORI ANTIABBAGLIAMENTO</b></p>  <p>Nido d'ape il nido d'ape è applicabile sull'ottica diffusa e con cassaforma per installazione arretrata</p>		<p><b>WHBR2000</b> lunghezza: 140 mm</p>

## ESEMPIO DI CONFIGURAZIONE DI BRENTA 2 CUSTOM

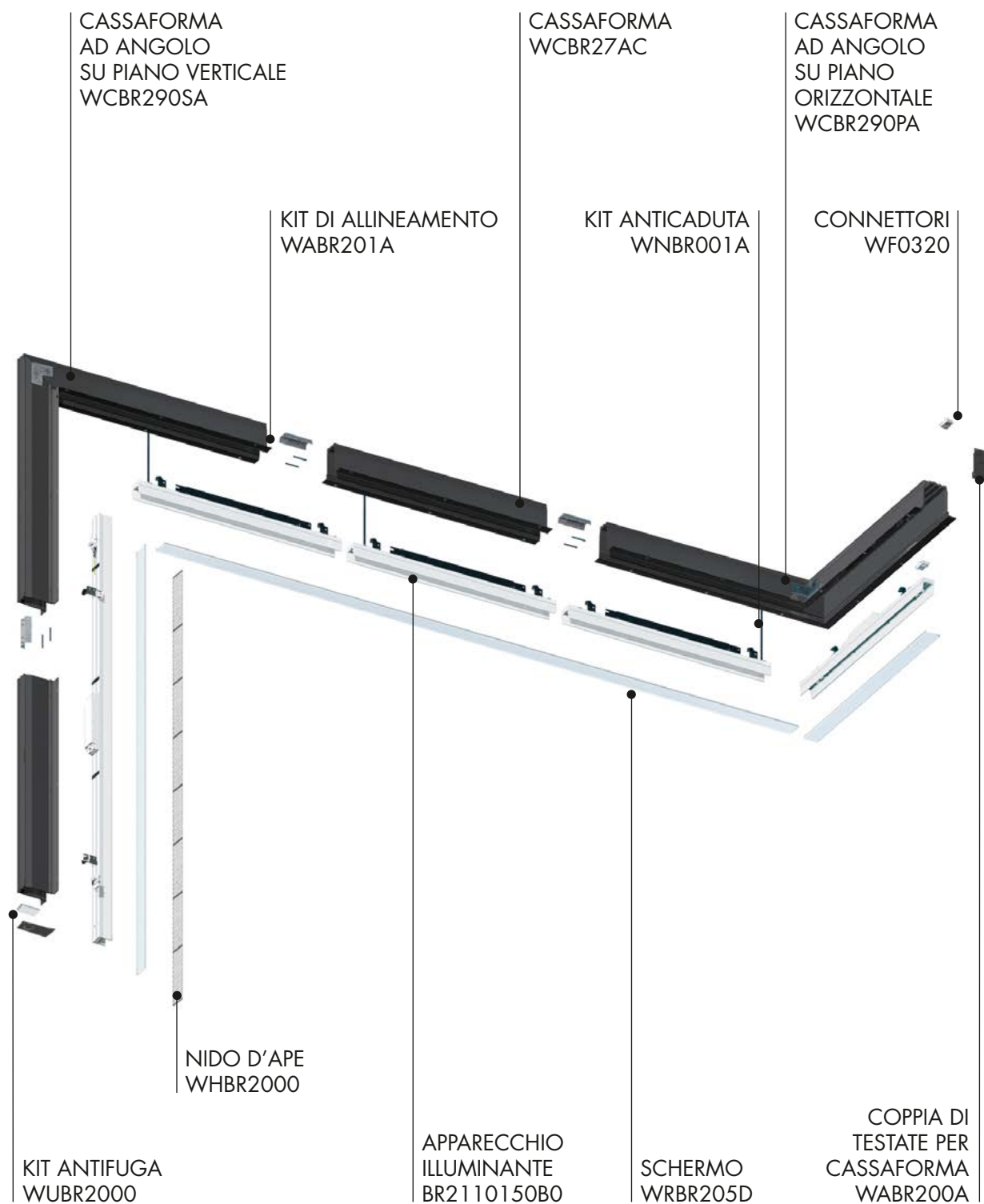

## PROFILI LINEARI DA INTERNO

### BRENTA 1

**Diffuso**  
installazione a filo - 562 mm

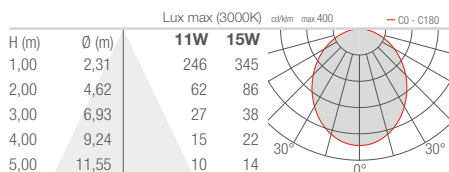

**Microprismatizzato**  
installazione a filo - 562 mm

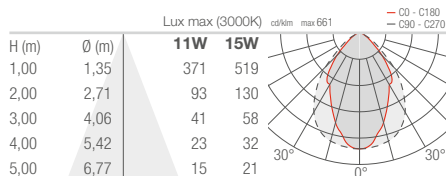

**Diffuso**  
installazione arretrata - 562 mm

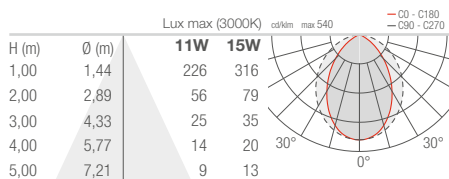

**Microprismatizzato**  
installazione arretrata - 562 mm

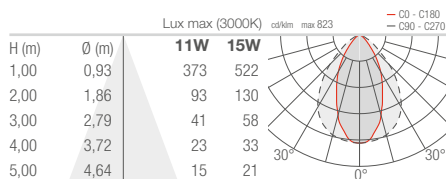

### BRENTA 2

**Diffuso**  
installazione a filo - 562 mm

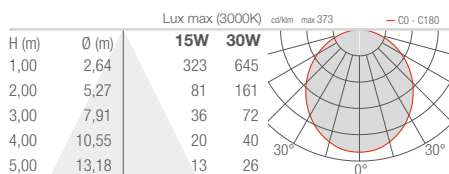

**Microprismatizzato**  
installazione a filo - 562 mm

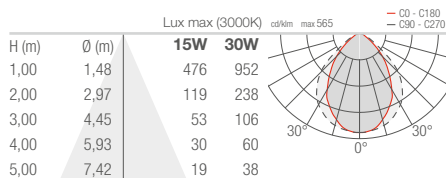

**Diffuso**  
installazione arretrata - 562 mm

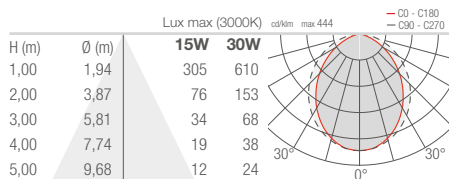

**Microprismatizzato**  
installazione arretrata - 562 mm

