

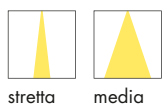

^
ESEM 3.2
 3000K, 8W, nero

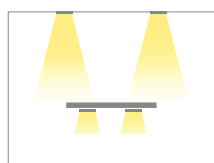

stretta media

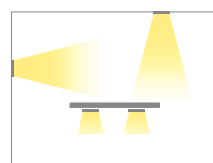

stretta media larga ellittica

OTTICA FISSA

Ø31 mm



ESEM MINI 1.0 p. 556
 max 2W max 500mA
 corrente costante

ESEM MINI 1.6 p. 557
 2W 24Vdc
 tensione costante



2700K 3000K 4000K 5000K

Ø46 mm



ESEM MID 1.0 p. 558
 max 3W max 350mA
 corrente costante

ESEM MID 1.6 p. 559
 3W 24Vdc
 tensione costante



2700K 3000K 4000K 5000K

OTTICA ORIENTABILE

Ø40 mm



ESEM MINI 1.1 p. 556
 max 2W max 500mA
 corrente costante

ESEM MINI 1.7 p. 557
 2W 24Vdc
 tensione costante

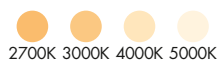

2700K 3000K 4000K 5000K

Ø55 mm



ESEM MID 1.1 p. 558
 max 3W max 350mA
 corrente costante

ESEM MID 1.7 p. 559
 3W 24Vdc
 tensione costante



2700K 3000K 4000K 5000K

INCASSI DOWNLIGHT DA INTERNO VETRINE E CONTROSOFFITTI IN CONTESTI RESIDENZIALI E HOSPITALITY

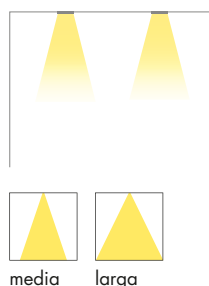
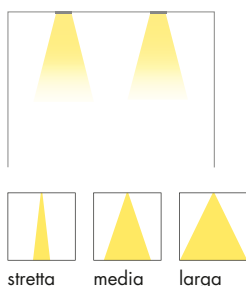

Ø38 mm



ESEM 2.0 p. 561
max 2W max 500mA
corrente costante

ESEM 2.6 p. 561
2W 24Vdc
tensione costante



Ø59 mm



ESEM 3.0 p. 562
8W 230Vac
ON/OFF, DALI
tensione di rete



Ø75 mm



ESEM 4.0 p. 564
14W 230Vac
ON/OFF, DALI,
0/1-10V , taglio di fase
tensione di rete



Ø74 mm



ESEM 3.1 p. 563
8W 230Vac
ON/OFF, DALI,
0/1-10V
tensione di rete



Ø74 mm



ESEM 3.2 p. 563
8W 230Vac
ON/OFF, DALI,
0/1-10V
tensione di rete



Ø89 mm



ESEM 4.1 p. 565
14W 230Vac
ON/OFF, DALI,
0/1-10V, taglio di fase
tensione di rete



Ø89 mm



ESEM 4.2 p. 565
14W 230Vac
ON/OFF, DALI,
0/1-10V, taglio di fase
tensione di rete



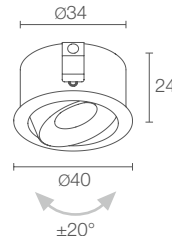
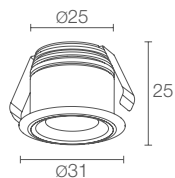

ESEM MINI 1.0



POTENZA / ALIMENTAZIONE CODICE

max 2W max 500mA
ME1012 ■ **B** Bianco
ME1012 ■ **N** Nero
ME1012 ■ **A** Anodizzato grigio

COLORE LED

F - 2700K
5 - 3000K
9 - 4000K
0 - 5000K

OTTICHE

S - 14°
M - 27°

ESEM MINI 1.1

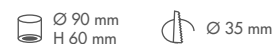

max 2W max 500mA
ME1112 ■ **B** Bianco
ME1112 ■ **N** Nero
ME1112 ■ **A** Anodizzato grigio

F - 2700K
5 - 3000K
9 - 4000K
0 - 5000K

S - 14° orientabile ±20°
M - 27° orientabile ±20°

FLUSSO SORGENTE	145 lm (3000K, 500mA)
FLUSSO EMESSE	125 lm (3000K, 500mA, 27°)
NUMERO E TIPO LED	1 power LED 1/4 ANSI BIN, 50000h L90 B10 (Ta 25°C)
MATERIALE	corpo in alluminio
ALIMENTATORE	non incluso, vedi pag. 904
CAVI DI ALIMENTAZIONE	inclusi 2 cavi unipolari di 0,50 m
COLLEGAMENTO	in serie
MONTAGGIO	a incasso (soffitto, mensola)
NOTE	su richiesta disponibile la versione certificata ETL
DATI FOTOMETRICI	vedi pag. 826

FLUSSO SORGENTE	145 lm (3000K, 500mA)
FLUSSO EMESSE	125 lm (3000K, 500mA, 27°)
NUMERO E TIPO LED	1 power LED 1/4 ANSI BIN, 50000h L90 B10 (Ta 25°C)
MATERIALE	corpo in alluminio
ALIMENTATORE	non incluso, vedi pag. 904
CAVI DI ALIMENTAZIONE	inclusi 2 cavi unipolari di 0,50 m
COLLEGAMENTO	in serie
MONTAGGIO	a incasso (soffitto, mensola)
NOTE	su richiesta disponibile la versione certificata ETL
DATI FOTOMETRICI	vedi pag. 826



ESEM MINI 1.6

Ø 90 mm
H 60 mm
Ø 27 mm

CE CB ENEC LED TECH III kg 0,045 IP20
A A+ A++ CASAMBI

2W 24Vdc

ME1600 ■ **B** Bianco
ME1600 ■ **N** Nero
ME1600 ■ **A** Anodizzato grigio

■ **F** - 2700K
S - 3000K
9 - 4000K
0 - 5000K

■ **S** - 14°
M - 27°

145 lm (3000K)

125 lm (3000K, 27°)

1 power LED
1/4 ANSI BIN, 50000h L90 B10 (Ta 25°C)

corpo in alluminio

non incluso, vedi pag. 904

incluso cavo in PVC di 1,5 m
FROR 2x0,35/0,35 Ø3,5 mm

in parallelo

a incasso (soffitto, mensola)

su richiesta disponibile la versione certificata ETL

vedi pag. 826



ESEM MINI 1.7

Ø 90 mm
H 60 mm
Ø 35 mm

CE CB ENEC LED TECH III kg 0,07 IP20
A A+ A++ CASAMBI

2W 24Vdc

ME1700 ■ **B** Bianco
ME1700 ■ **N** Nero
ME1700 ■ **A** Anodizzato grigio

■ **F** - 2700K
S - 3000K
9 - 4000K
0 - 5000K

■ **S** - 14° orientabile ±20°
M - 27° orientabile ±20°

145 lm (3000K)

125 lm (3000K, 27°)

1 power LED
1/4 ANSI BIN, 50000h L90 B10 (Ta 25°C)

corpo in alluminio

non incluso, vedi pag. 904

incluso cavo in PVC di 1,5 m
FROR 2x0,35/0,35 Ø3,5 mm

in parallelo

a incasso (soffitto, mensola)

su richiesta disponibile la versione certificata ETL

vedi pag. 826



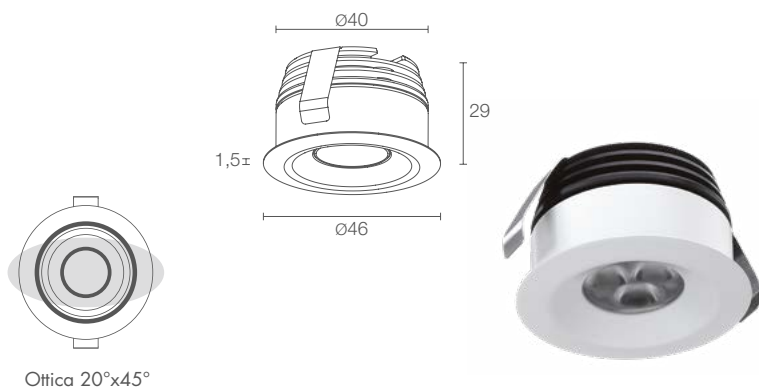

ESEM MID 1.0

Ø 90 mm
H 80 mm

Ø 41 mm

CE CB EAC LED TECH III kg 0,09 IP40
A A+ A++ CASAMBI

POTENZA / ALIMENTAZIONE CODICE

max 3W max 350mA
EM1031 ■ ■ **B** Bianco
EM1031 ■ ■ **N** Nero
EM1031 ■ ■ **A** Anodizzato grigio

COLORE LED

F - 2700K
5 - 3000K
9 - 4000K
0 - 5000K

OTTICHE

S - 11°
M - 22°
L - 30°
W - 20°x45°

ESEM MID 1.1

Ø 90 mm
H 80 mm

Ø 50 mm

CE CB EAC LED TECH III kg 0,09 IP40
A A+ A++ CASAMBI

max 3W max 350mA
EM1131 ■ ■ **B** Bianco
EM1131 ■ ■ **N** Nero
EM1131 ■ ■ **A** Anodizzato grigio

F - 2700K
5 - 3000K
9 - 4000K
0 - 5000K

S - 11° orientabile ±20°
M - 22° orientabile ±20°
L - 30° orientabile ±20°
W - 20°x45° orientabile ±20°

FLUSSO SORGENTE	309 lm (3000K, 350mA)
FLUSSO EMESSO	220 lm (3000K, 350mA, 22°)
NUMERO E TIPO LED	3 power LED 1/4 ANSI BIN, 50000h L95 B10 (Ta 25°C)
MATERIALE	corpo e ghiera in alluminio
ALIMENTATORE	non incluso, vedi pag. 904
CAVI DI ALIMENTAZIONE	incluso cavo in PVC di 1,5 m FROR 2x0,35 Ø3,5 mm
COLLEGAMENTO	in serie
MONTAGGIO	a incasso (soffitto, parete, mensola)
NOTE	su richiesta disponibile la versione IP44
DATI FOTOMETRICI	vedi pag. 826

FLUSSO SORGENTE	309 lm (3000K, 350mA)
FLUSSO EMESSO	220 lm (3000K, 350mA, 22°)
NUMERO E TIPO LED	3 power LED 1/4 ANSI BIN, 50000h L95 B10 (Ta 25°C)
MATERIALE	corpo e ghiera in alluminio
ALIMENTATORE	non incluso, vedi pag. 904
CAVI DI ALIMENTAZIONE	incluso cavo in PVC di 1,5 m FROR 2x0,35 Ø3,5 mm
COLLEGAMENTO	in serie
MONTAGGIO	a incasso (soffitto, parete, mensola)
NOTE	su richiesta disponibile la versione IP44
DATI FOTOMETRICI	vedi pag. 826



ESEM MID 1.6

Ø 90 mm
H 80 mm

Ø 41 mm

CE CB ENEC LED TECH III kg 0,09 IP40

A A+ A++ CASAMBI

3W 24Vdc

EM1600 ■ ■ B Bianco

EM1600 ■ ■ N Nero

EM1600 ■ ■ A Anodizzato grigio

■ **F** - 2700K
5 - 3000K
9 - 4000K
0 - 5000K

■ **S** - 11°
M - 22°
L - 30°
W - 20°x45°

309 lm (3000K)

220 lm (3000K, 22°)

3 power LED
1/4 ANSI BIN, 50000h L95 B10 (Ta 25°C)

corpo e ghiera in alluminio

non incluso, vedi pag. 904

incluso cavo in PVC di 1,5 m
FROR 2x0,35/0,35 Ø3,5 mm

in parallelo

a incasso (soffitto, parete, mensola)

su richiesta disponibile la versione IP44

vedi pag. 826

ESEM MID 1.7

Ø 90 mm
H 80 mm

Ø 50 mm

CE CB ENEC LED TECH III kg 0,09 IP40

A A+ A++ CASAMBI

3W 24Vdc

EM1700 ■ ■ B Bianco

EM1700 ■ ■ N Nero

EM1700 ■ ■ A Anodizzato grigio

■ **F** - 2700K
5 - 3000K
9 - 4000K
0 - 5000K

■ **S** - 11° orientabile ±20°
M - 22° orientabile ±20°
L - 30° orientabile ±20°
W - 20°x45° orientabile ±20°

309 lm (3000K)

220 lm (3000K, 22°)

3 power LED
1/4 ANSI BIN, 50000h L95 B10 (Ta 25°C)

corpo e ghiera in alluminio

non incluso, vedi pag. 904

incluso cavo in PVC di 1,5 m
FROR 2x0,35/0,35 Ø3,5 mm

in parallelo

a incasso (soffitto, parete, mensola)

su richiesta disponibile la versione IP44

vedi pag. 826



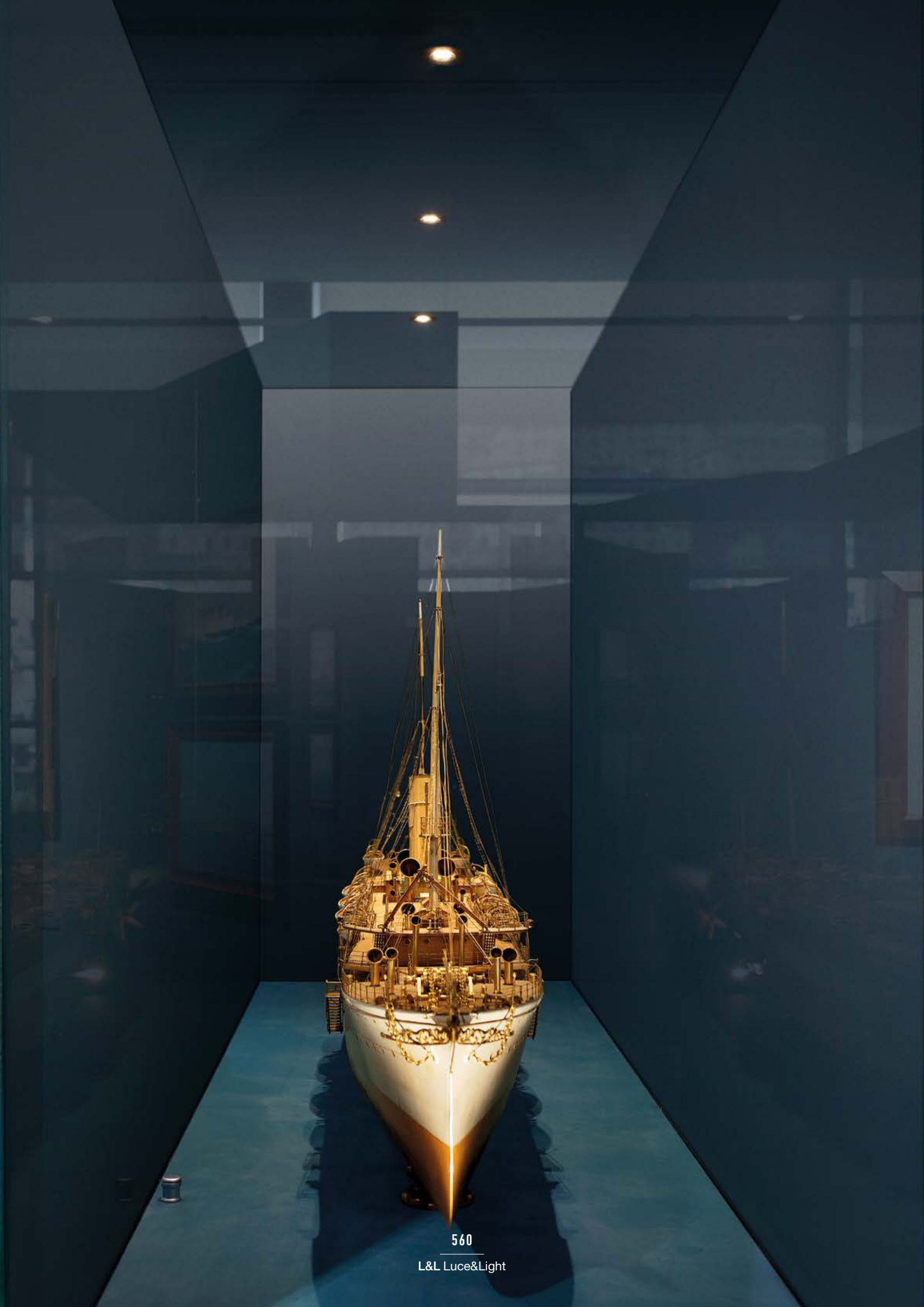

560

L&L Luce&Light



ESEM 2.0

Ø 130 mm
H 90 mm

Ø 30 mm

CE CB ENEC LED TECH III kg 0,09 IP40

A A+ A++ EPS CASAMBI

POTENZA / ALIMENTAZIONE CODICE

max 2W max 500mA
ES2012 ■ ■ ■ E B Bianco

COLORE LED

F - 2700K
5 - 3000K
9 - 4000K
0 - 5000K

OTTICHE

S - 16°
M - 36°
L - 80°

ESEM 2.6

Ø 130 mm
H 90 mm

Ø 30 mm

CE CB ENEC LED TECH III kg 0,09 IP40

A A+ A++ EPS CASAMBI

2W 24Vdc
ES2600 ■ ■ ■ B Bianco

F - 2700K
5 - 3000K
9 - 4000K
0 - 5000K

S - 16°
M - 36°
L - 80°

FLUSSO SORGENTE	145 lm (3000K, 500mA)
FLUSSO EMESSO	122 lm (3000K, 500mA, 36°)
NUMERO E TIPO LED	1 power LED 1/4 ANSI BIN, 50000h L90 B10 (Ta 25°C)
MATERIALE	corpo in alluminio
ALIMENTATORE	non incluso, vedi pag. 904
CAVI DI ALIMENTAZIONE	incluso cavo in PVC di 1,5 m FROR 2x0,35 Ø3,5 mm
COLLEGAMENTO	in serie
MONTAGGIO	a incasso (soffitto)
ACCESSORI	WF0110 cavo in PVC FROR 2x0,35 Ø3,5 mm lunghezza su richiesta da ordinare contestualmente all'apparecchio illuminante
DATI FOTOMETRICI	vedi pag. 826

FLUSSO SORGENTE	145 lm (3000K)
FLUSSO EMESSO	122 lm (3000K, 36°)
NUMERO E TIPO LED	1 power LED 1/4 ANSI BIN, 50000h L90 B10 (Ta 25°C)
MATERIALE	corpo in alluminio
ALIMENTATORE	non incluso, vedi pag. 904
CAVI DI ALIMENTAZIONE	incluso cavo in PVC di 1,5 m FROR 2x0,35 Ø3,5 mm
COLLEGAMENTO	in parallelo
MONTAGGIO	a incasso (soffitto)
ACCESSORI	non previsti
DATI FOTOMETRICI	vedi pag. 826



< **ESEM MID 1.1**
3000K, 3W, 30°, nero

Project by / Studio ARCHH Lorenzo Agnese,
Giovanni Guerrieri
Photo by / Alessio Tamborini
Sala Coeclerici, Galata Museo del Mare
Genova, Italia

✓
ESEM 3.1
 3000K, 8W, 20°, bianco

Interior design by / Cristian Turra
 Photo by / Alessio Tamborini
 Abitazione privata, Brescia, Italia



ESEM 3.0

Ø 170 mm H 150 mm Ø 50 mm

CE ENEC LED TECH DALI kg 0,25 IP40
 A A+ A++ DALI PUSH

POTENZA / ALIMENTAZIONE 8W 230Vac
CODICE ES3010 B Bianco
 ES3010 N Nero
 8W 230Vac DALI + PUSH
 ES3010 BD Bianco
 ES3010 ND Nero

COLORE LED	F - 2700K 5 - 3000K 9 - 4000K
OTTICHE	S - 20° M - 30° L - 54°

FLUSSO SORGENTE	512 lm (3000K)
FLUSSO EMESSO	425 lm (3000K, 30°)
NUMERO E TIPO LED	1 power LED multichip 2 step MacAdam, 50000h L90 B10 (Ta 25°C)
MATERIALE	corpo e ghiera in alluminio
ALIMENTATORE	incluso e cablato
CAVI DI ALIMENTAZIONE	incluso cavo di 0,30 m
MONTAGGIO	a incasso (soffitto)
NOTE	su richiesta disponibile la versione con gestione Casambi, controllabile tramite app Casambi e la versione certificata ETL
DATI FOTOMETRICI	vedi pag. 827

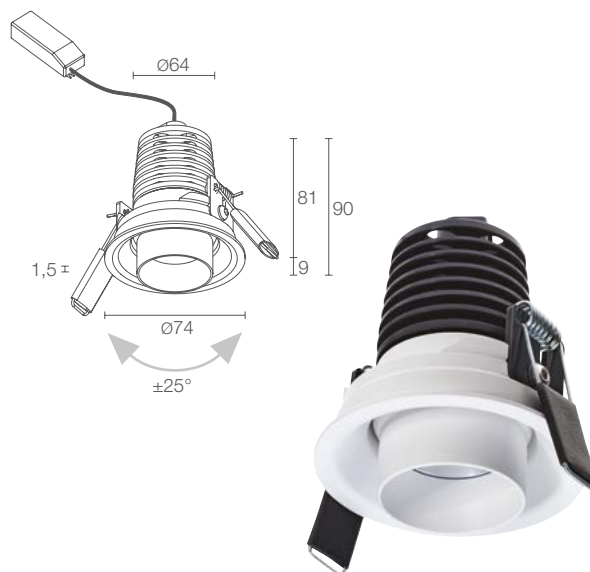

ESEM 3.1

Ø 180 mm
H 150 mm

Ø 65 mm

CE EAC LED TECH DALI kg 0,30 IP40
A A+ A++ DALI PUSH 0/1-10V

8W 230Vac

ES3100 ■ ■ B Bianco
ES3100 ■ ■ N Nero

8W 230Vac 0/1-10V + PUSH

ES3100 ■ ■ BR Bianco
ES3100 ■ ■ NR Nero

8W 230Vac DALI + PUSH

ES3100 ■ ■ BD Bianco
ES3100 ■ ■ ND Nero

■ F - 2700K
■ 5 - 3000K
■ 9 - 4000K

■ S - 20° orientabile ±25°
■ M - 30° orientabile ±25°
■ L - 54° orientabile ±25°

512 lm (3000K)

425 lm (3000K, 30°)

1 power LED multichip
2 step MacAdam, 50000h L90 B10 (Ta 25°C)

corpo e ghiera in alluminio

incluso e cablato

incluso cavo di 0,30 m

a incasso (soffitto)

su richiesta disponibile la versione con gestione Casambi, controllabile tramite app Casambi e la versione certificata ETL

vedi pag. 827

ESEM 3.2

Ø 180 mm
H 150 mm

Ø 65 mm

CE EAC LED TECH DALI kg 0,30 IP40
A A+ A++ DALI PUSH 0/1-10V

8W 230Vac

ES3200 ■ ■ B Bianco
ES3200 ■ ■ N Nero

8W 230Vac 0/1-10V + PUSH

ES3200 ■ ■ BR Bianco
ES3200 ■ ■ NR Nero

8W 230Vac DALI + PUSH

ES3200 ■ ■ BD Bianco
ES3200 ■ ■ ND Nero

■ F - 2700K
■ 5 - 3000K
■ 9 - 4000K

■ S - 16° orientabile ±25°
■ M - 29° orientabile ±25°
■ L - 46° orientabile ±25°

512 lm (3000K)

436 lm (3000K, 29°)

1 power LED multichip
2 step MacAdam, 50000h L90 B10 (Ta 25°C)

corpo e ghiera in alluminio

incluso e cablato

incluso cavo di 0,30 m

a incasso (soffitto)

su richiesta disponibile la versione con gestione Casambi, controllabile tramite app Casambi e la versione certificata ETL

vedi pag. 827



✓
ESEM 4.2
 3000K, 14W, 24°, bianco

Interior design by / Cristian Turra
 Photo by / Alessio Tamborini
 Abitazione privata, Brescia, Italia



ESEM 4.0

Ø 190 mm
 H 170 mm

Ø 65 mm

CE ENEC LED TECH
 kg 0,50 IP40
 A A+ A++ DALI PUSH 0/1-10V

POTENZA / ALIMENTAZIONE CODICE

14W 230Vac
ES4010 ■ ■ **B** Bianco
ES4010 ■ ■ **N** Nero

14W 230Vac 0/1-10V + PUSH
ES4010 ■ ■ **BR** Bianco
ES4010 ■ ■ **NR** Nero

14W 230Vac DALI + PUSH
ES4010 ■ ■ **BD** Bianco
ES4010 ■ ■ **ND** Nero

14W 230Vac TAGLIO DI FASE
ES4010 ■ ■ **BT** Bianco
ES4010 ■ ■ **NT** Nero

COLORE LED

F - 2700K
5 - 3000K
9 - 4000K

OTTICHE

M - 20°
L - 40°

FLUSSO SORGENTE	1219 lm (3000K)
FLUSSO EMESSO	957 lm (3000K, 20°)
NUMERO E TIPO LED	1 power LED multichip 2 step MacAdam, 50000h L85 B10 (Ta 25°C)
MATERIALE	corpo e ghiera in alluminio
ALIMENTATORE	incluso e cablato
CAVI DI ALIMENTAZIONE	incluso cavo di 0,30 m
MONTAGGIO	a incasso (soffitto)
NOTE	su richiesta disponibile la versione con gestione Casambi, controllabile tramite app Casambi e la versione certificata ETL
DATI FOTOMETRICI	vedi pag. 827



ESEM 4.1

Ø 200 mm
H 200 mm



CE ENEC LED TECH IP40
A A+ A++ DALI PUSH 0/1-10V

14W 230Vac
ES4100 ■ ■ B Bianco
ES4100 ■ ■ N Nero

14W 230Vac 0/1-10V + PUSH
ES4100 ■ ■ BR Bianco
ES4100 ■ ■ NR Nero

14W 230Vac DALI + PUSH
ES4100 ■ ■ BD Bianco
ES4100 ■ ■ ND Nero

14W 230Vac TAGLIO DI FASE
ES4100 ■ ■ BT Bianco
ES4100 ■ ■ NT Nero

■ F - 2700K
 ■ 5 - 3000K
 ■ 9 - 4000K

■ M - 20° orientabile ±25°
 L - 40° orientabile ±25°

1219 lm (3000K)

957 lm (3000K, 20°)

1 power LED multichip
 2 step MacAdam, 50000h L85 B10 (Ta 25°C)

corpo e ghiera in alluminio

incluso e cablato

incluso cavo di 0,30 m

a incasso (soffitto)

su richiesta disponibile la versione con gestione Casambi, controllabile tramite app Casambi e la versione certificata ETL

vedi pag. 827

ESEM 4.2

Ø 200 mm
H 200 mm



CE ENEC LED TECH IP40
A A+ A++ DALI PUSH 0/1-10V

14W 230Vac
ES4200 ■ ■ B Bianco
ES4200 ■ ■ N Nero

14W 230Vac 0/1-10V + PUSH
ES4200 ■ ■ BR Bianco
ES4200 ■ ■ NR Nero

14W 230Vac DALI + PUSH
ES4200 ■ ■ BD Bianco
ES4200 ■ ■ ND Nero

14W 230Vac TAGLIO DI FASE
ES4200 ■ ■ BT Bianco
ES4200 ■ ■ NT Nero

■ F - 2700K
 ■ 5 - 3000K
 ■ 9 - 4000K

■ M - 24° orientabile ±20°
 L - 37° orientabile ±20°

1219 lm (3000K)

940 lm (3000K, 24°)

1 power LED multichip
 2 step MacAdam, 50000h L85 B10 (Ta 25°C)

corpo e ghiera in alluminio

incluso e cablato

incluso cavo di 0,30 m

a incasso (soffitto)

su richiesta disponibile la versione con gestione Casambi, controllabile tramite app Casambi e la versione certificata ETL

vedi pag. 827



ESEM MINI 1.0

1.1
1.6
1.7

S - 14°

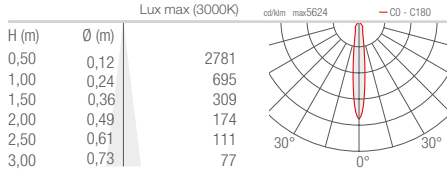

M - 27°

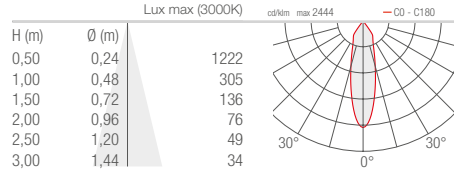

ESEM MID 1.0

1.1
1.6
1.7

S - 11°

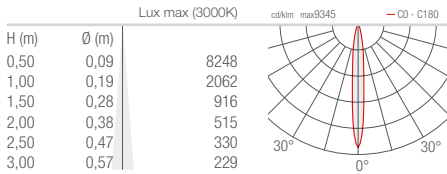

M - 22°

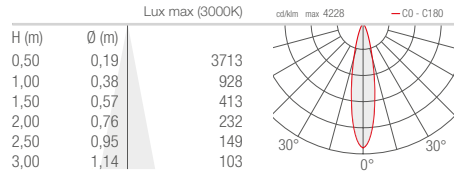

L - 30°

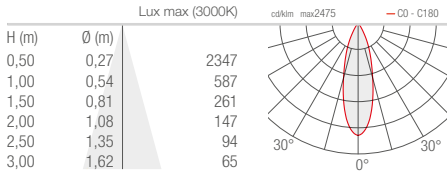

W - 20°x45°

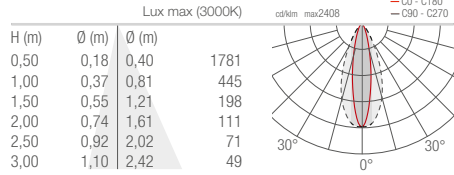

ESEM 2.0

2.6

S - 16°

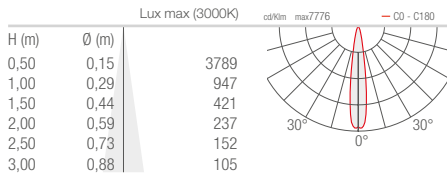

M - 36°

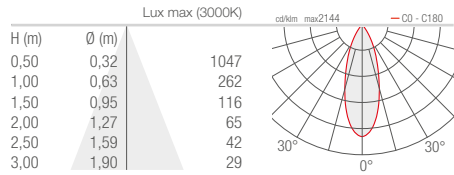

L - 80°

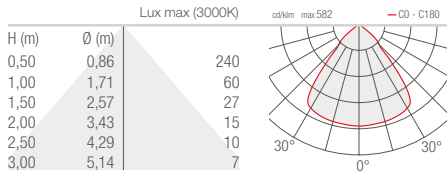

ESEM 3.0
3.1

S - 20°

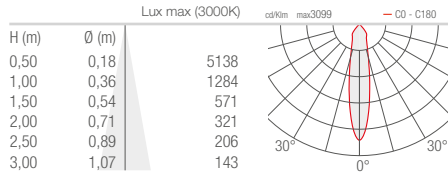

M - 30°

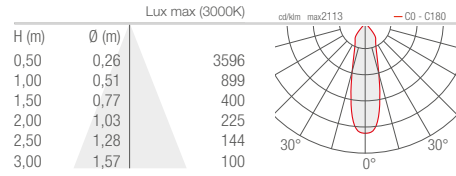

L - 54°

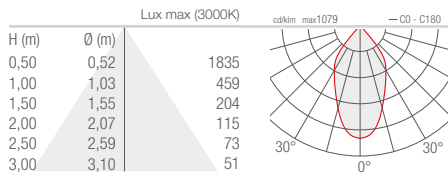

ESEM 3.2

S - 16°

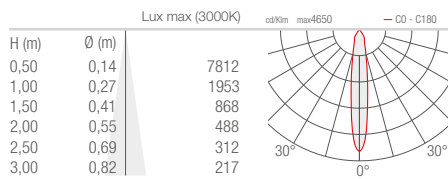

M - 29°

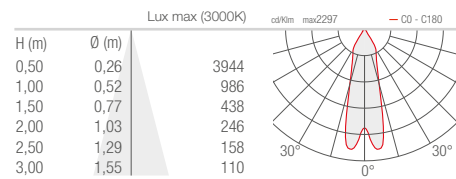

L - 46°

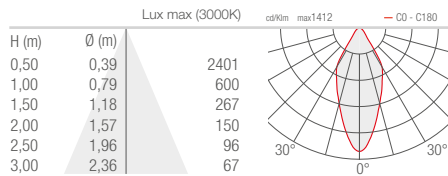

ESEM 4.0
4.1

M - 20°

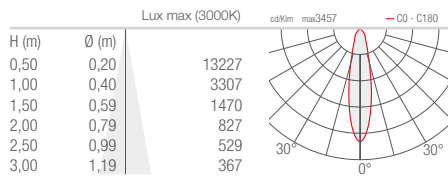

L - 40°

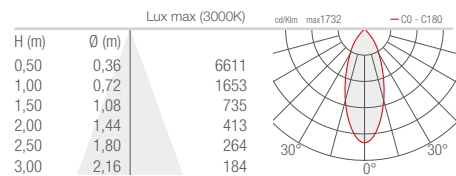

ESEM 4.2

M - 24°

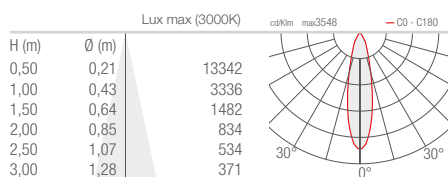

L - 37°

