



644

L&L Luce&Light

# INTONO C IN

## PLAFONIERE DA INTERNO CON SOLA EMISSIONE LUMINOSA O CON CASSA AUDIO PER CONTESTI RESIDENZIALI E HOSPITALITY



stretta

media

larga

diffusa

asimmetrica



2700K 3000K 4000K

### INTERNO

### ESTERNO

#### PLAFONIERE

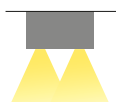

INTONO C IN 2.3 p. 646  
12W 230Vac  
ON/OFF

INTONO C OUT p. 374



INTONO C IN 3.3 p. 647  
20W 230Vac  
ON/OFF, DALI, 0/1-10V

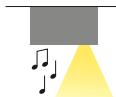

INTONO C IN 3.8 p. 647  
9W 24Vdc

#### APPLIQUE

INTONO p. 324



### ^ INTONO C IN 3.8

cassa audio:  
potenza massima  
impedenza nominale Z  
livello medio di pressione sonora

3W  
16 Ohm  
86 dB (1W/1m)

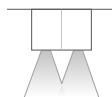

### INTONO C IN 2.3

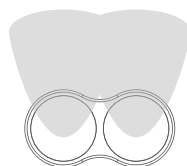
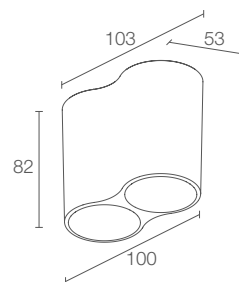

Optica asimmetrica  
(Intono C IN 3.3)

### v INTONO C IN 3.3

versione primer verniciata



#### POTENZA / ALIMENTAZIONE CODICE

12W 230Vac

NC2310 00 B Bianco

NC2310 00 N Nero

NC2310 00 Z Bronzo antico

NC2310 00 7 Primer

**CRI**  
0 - CRI 80  
1 - CRI >90

**GESTIONE DI CONTROLLO** on/off

**NIDO D'APE**  
0 - non presente  
1 - presente  
(non applicabile sull'ottica diffusa)

**COLORE LED**  
F - 2700K  
5 - 3000K  
9 - 4000K

**OTTICHE**  
TT - 11°  
MM - 34°  
KK - 68°  
DD - diffusa

FLUSSO SORGENTE 976 lm (3000K, CRI 80)

FLUSSO EMESSO 704 lm (3000K, 34°, CRI 80)

NUMERO E TIPO LED  
2 power LED  
3 step MacAdam, 50000h L90 B10 (Ta 25°C)

MATERIALE  
corpo in alluminio pressofuso  
schermo in vetro extrachiaro temprato trasparente  
e serigrafato nero

ALIMENTATORE integrato

MONTAGGIO su superficie (soffitto)

ACCESSORI non previsti

CARATTERISTICHE  
installazione facilitata grazie all'attacco magnetico  
in quattro punti

NOTE  
versione da esterno Intono C OUT 2.4 pag. 376  
versione applique Intono pag. 324  
su richiesta versione compatibile con  
Google Home o Amazon Echo  
per controllo tramite comandi vocali  
su richiesta disponibile la versione con gestione  
Casambi, controllabile tramite app Casambi

DATI FOTOMETRICI vedi pag. 839

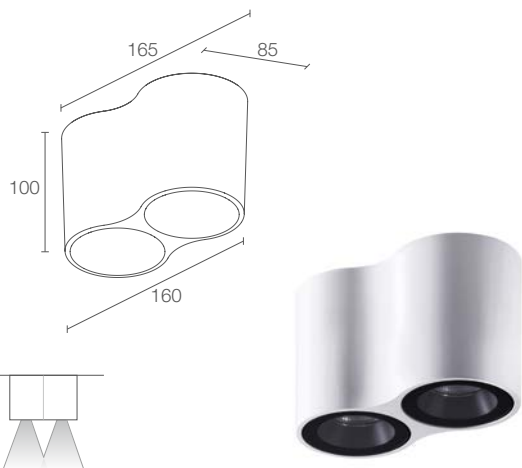

## INTONO C IN 3.3

CE kg 1,15 IP40 IK06 DALI 0/1-10V

20W 230Vac

**NC3310** **B** Bianco  
**NC3310** **N** Nero  
**NC3310** **Z** Bronzo antico  
**NC3310** **7** Primer

**0** - CRI 80  
**1** - CRI >90

**0** - on/off  
**D** - DALI  
**R** - 0/1-10V

**0** - non presente  
**1** - presente  
 (non applicabile sull'ottica asimmetrica)

**F** - 2700K  
**5** - 3000K  
**9** - 4000K

**SS** - 15°  
**MM** - 20°  
**LL** - 43°  
**AA** - asimmetrica

1976 lm (3000K, CRI 80)

1674 lm (3000K, 15°, CRI 80)

2 COB LED High Density  
 2 step MacAdam, 50000h L95 B10 (Ta 25°C)

corpo in alluminio pressofuso  
 schermo in vetro extrachiaro temprato trasparente  
 e serigrafato nero

integrato

su superficie (soffitto)

non previsti

installazione facilitata grazie all'attacco magnetico  
 in quattro punti

versione da esterno Intono C OUT 3.4 pag. 377  
 versione applique Intono pag. 324  
 su richiesta versione compatibile con  
 Google Home o Amazon Echo  
 per controllo tramite comandi vocali  
 su richiesta disponibile la versione con gestione  
 Casambi, controllabile tramite app Casambi

vedi pag. 839

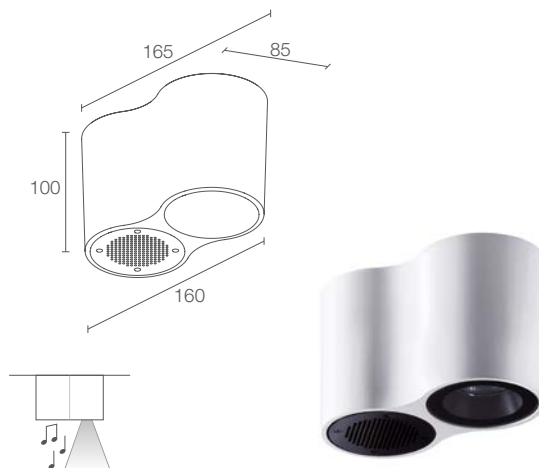

## INTONO C IN 3.8

CE kg 1,15 IP40 IK06

9W 24Vdc

**NC3800** **M9 B** Bianco  
**NC3800** **M9 N** Nero  
**NC3800** **M9 Z** Bronzo antico  
**NC3800** **M9 7** Primer

**0** - CRI 80  
**1** - CRI >90

**0** - non presente  
**1** - presente

**F** - 2700K  
**5** - 3000K  
**9** - 4000K

20°

988 lm (3000K, CRI 80)

783 lm (3000K, 20°, CRI 80)

1 COB LED High Density  
 2 step MacAdam, 50000h L95 B10 (Ta 25°C)

corpo in alluminio pressofuso  
 schermo in vetro extrachiaro temprato trasparente  
 e serigrafato nero

non incluso, vedi pag. 904

su superficie (soffitto)

vedi pag. 649

installazione facilitata grazie all'attacco magnetico  
 in quattro punti

versione da esterno Intono C OUT 3.9 pag. 377  
 versione applique Intono pag. 324  
 su richiesta versione compatibile con  
 Google Home o Amazon Echo  
 per controllo tramite comandi vocali  
 su richiesta disponibile la versione con gestione  
 Casambi, controllabile tramite app Casambi

vedi pag. 839

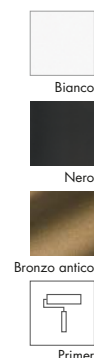

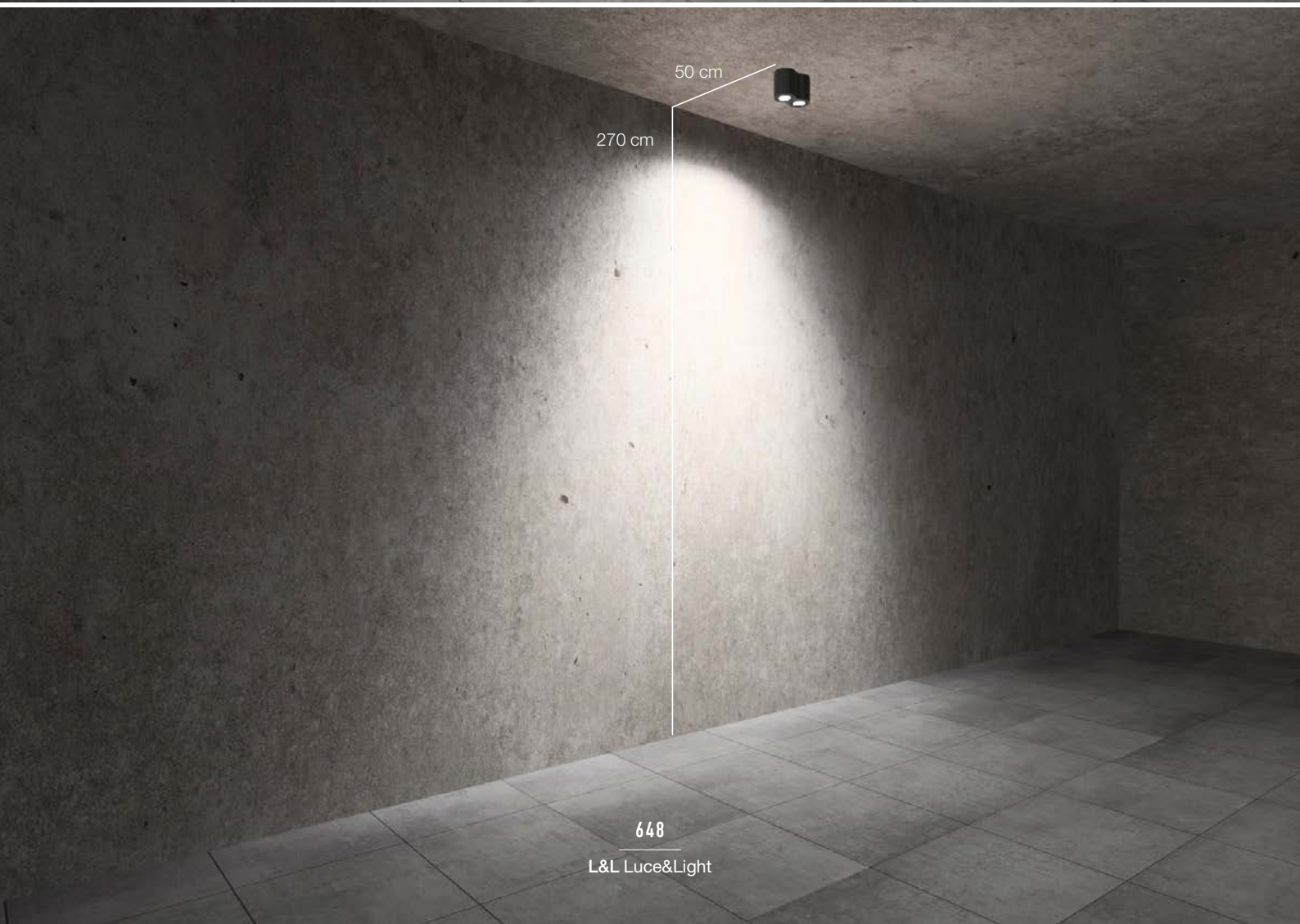

## ACCESSORI

### ACCESSORI



#### **WUNT39A00**

Kit controller audio bluetooth 3.0  
con alimentatore e amplificatore  
(per sistema controllo vocale  
Alexa o Google Home)  
(Intono C IN 3.8)



#### **WUNT39A01**

Kit controller luce Wi-Fi  
(Intono C IN 3.8)

## INTONO C IN 2.3 INTONO C OUT 2.4

### TT - 11° CRI 80

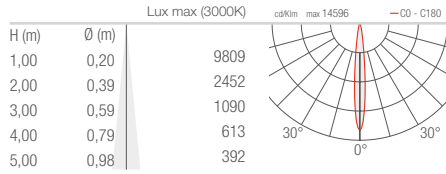

### MM - 34° CRI 80

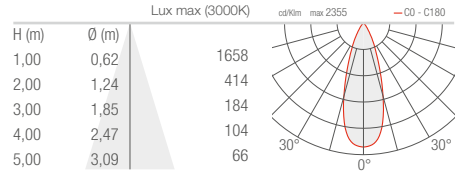

### KK - 68° CRI 80

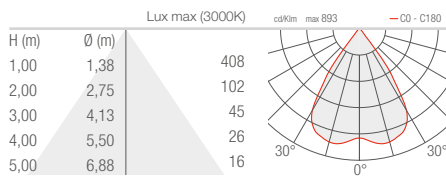

### DD - Diffusa CRI 80

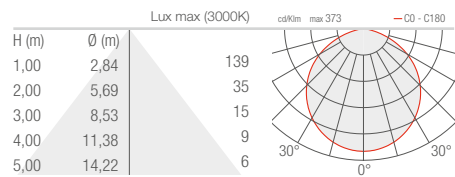

## INTONO C IN 3.3 INTONO C OUT 3.4

### SS - 15° CRI 80

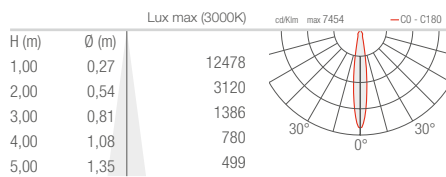

### MM - 20° CRI 80

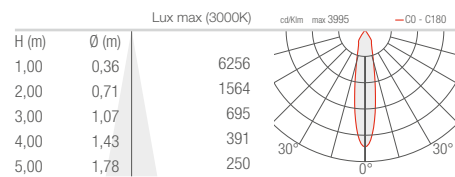

### LL - 43° CRI 80

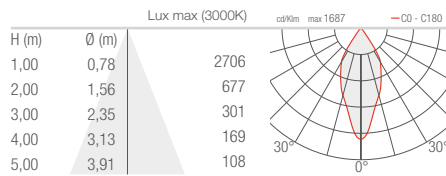

### AA - Asimmetrica CRI 80

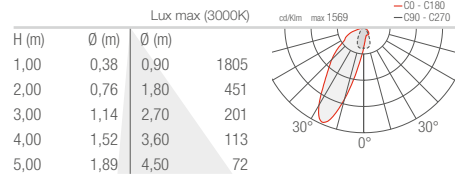

## INTONO C IN 3.8 INTONO C OUT 3.9

### M - 20° CRI 80

