





LAMPADE DA LETTURA PER CONTESTI RESIDENZIALI E HOSPITALITY



**MONTAGGIO
SU PARETE**



**MONTAGGIO
SU FRUTTO CIECO**



**MONTAGGIO
SU MENSOLA**

ZOOM OTTICO



zoom ottico



WALL 1 p. 634
2,5W 230Vac
3,5W 230Vac



WALL 3 p. 635
2,5W 230Vac
3,5W 230Vac

VERSIONE CON OTTICHE

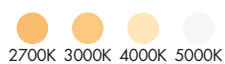

stretta media larga



WALL 8.1 p. 637
2,5W 230Vac
3,5W 230Vac



WALL 8.0 p. 636
max 2W max 500mA



WALL 8.2 p. 637
2,5W 230Vac
3,5W 230Vac

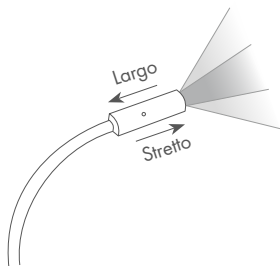

Emissione regolabile

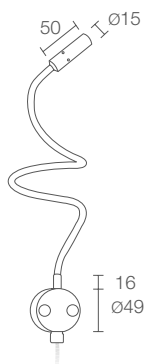

Stelo flessibile:
 Ø6 mm - 400 mm
 Ø8 mm - 400/500 mm

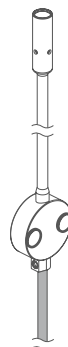

Versione standard:
 uscita cavo inferiore

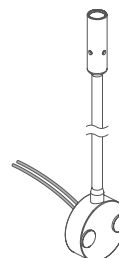

Versione su richiesta:
 uscita cavo posteriore



WALL 1

CE EAC LED TECH IP20
 A A+ A++
 kg 0,30 400 mm Ø6 mm
 kg 0,32 400 mm Ø8 mm
 kg 0,33 500 mm Ø8 mm

POTENZA / ALIMENTAZIONE CODICE	2,5W 230Vac	400 mm	stelo Ø6 mm
L11640 C	Cromato		
L11640 D	Dorato		
L11640 S	Satinato		
	3,5W 230Vac	400 mm	stelo Ø6 mm
L12640 C	Cromato		
L12640 D	Dorato		
L12640 S	Satinato		
	2,5W 230Vac	400 mm	stelo Ø8 mm
L11840 C	Cromato		
L11840 D	Dorato		
L11840 S	Satinato		
	3,5W 230Vac	400 mm	stelo Ø8 mm
L12840 C	Cromato		
L12840 D	Dorato		
L12840 S	Satinato		
	2,5W 230Vac	500 mm	stelo Ø8 mm
L11850 C	Cromato		
L11850 D	Dorato		
L11850 S	Satinato		
	3,5W 230Vac	500 mm	stelo Ø8 mm
L12850 C	Cromato		
L12850 D	Dorato		
L12850 S	Satinato		

COLORE LED	5 - 3000K 0 - 5000K
-------------------	------------------------

OTTICHE	range ottico 20°÷55°
----------------	----------------------

FLUSSO SORGENTE	145 lm (3000K, 3,5W)
FLUSSO EMESSO	61 lm (3000K, 3,5W)
NUMERO E TIPO LED	1 power LED 1/4 ANSI BIN, 50000h L90 B10 (Ta 25°C)
MATERIALE	corpo in alluminio, stelo in ottone
ALIMENTATORE	integrato nella spina con interruttore sul cavo
CAVI DI ALIMENTAZIONE	incluso cavo di 1,5 m, con spina e alimentatore integrato
MONTAGGIO	su superficie (parete)
NOTE	su richiesta disponibile la versione con uscita cavo posteriore su richiesta disponibile la versione con gestione Casambi, controllabile tramite app Casambi
DATI FOTOMETRICI	vedi pag. 900



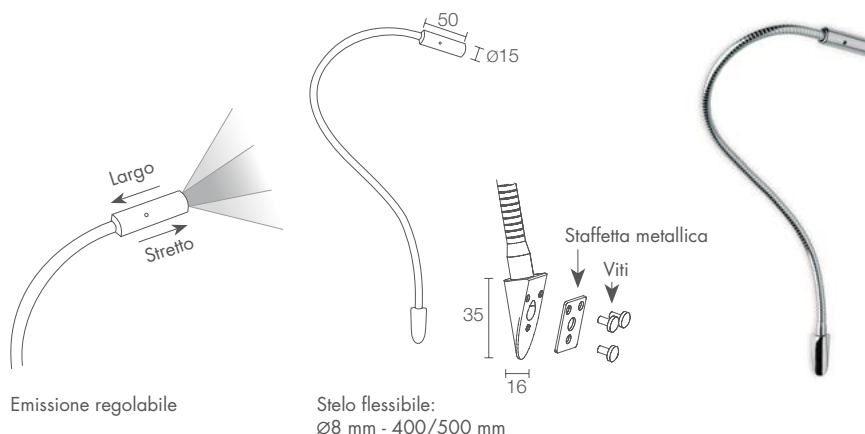

Emissione regolabile

Stelo flessibile:
Ø8 mm - 400/500 mm

WALL 3

CE ENEC LED TECH IP20
kg 0,19 400 mm
kg 0,29 500 mm

A A+ A++

POTENZA / ALIMENTAZIONE CODICE	2,5W 230Vac 400 mm stelo Ø8 mm
PL11840 ■ C	Cromato
PL11840 ■ D	Dorato
PL11840 ■ S	Satinato
	3,5W 230Vac 400 mm stelo Ø8 mm
PL12840 ■ C	Cromato
PL12840 ■ D	Dorato
PL12840 ■ S	Satinato
	2,5W 230Vac 500 mm stelo Ø8 mm
PL11850 ■ C	Cromato
PL11850 ■ D	Dorato
PL11850 ■ S	Satinato
	3,5W 230Vac 500 mm stelo Ø8 mm
PL12850 ■ C	Cromato
PL12850 ■ D	Dorato
PL12850 ■ S	Satinato

COLORE LED

5 - 3000K
0 - 5000K

OTTICHE

range ottico 20°÷55°

FLUSSO SORGENTE	145 lm (3000K, 3,5W)
FLUSSO EMESSO	61 lm (3000K, 3,5W)
NUMERO E TIPO LED	1 power LED 1/4 ANSI BIN, 50000h L90 B10 (Ta 25°C)
MATERIALE	corpo in alluminio, stelo in ottone
ALIMENTATORE	incluso
CAVI DI ALIMENTAZIONE	incluso cavo bipolare di 0,30 m
MONTAGGIO	su frutto cieco
NOTE	su richiesta disponibile la versione con gestione Casambi, controllabile tramite app Casambi
DATI FOTOMETRICI	vedi pag. 900



Cromato



Dorato



Satinato

✓
WALL 1
 3000K, 2,5W, satinato, versione speciale
 con uscita cavo posteriore

Collezione privata, Milano, Italia
 Courtesy of / Susanna Roda



Stelo flessibile:
 Ø8 mm - 400 mm



WALL 8.0

CE ENEC LED TECH III kg 0,16 IP40

A A+ A++

POTENZA / ALIMENTAZIONE max 2W max 500mA 400 mm
CODICE PL801240 C Cromato
 PL801240 S Satinato

COLORE LED	F - 2700K 5 - 3000K 9 - 4000K 0 - 5000K
OTTICHE	S - 10° M - 25° L - 40°

FLUSSO SORGENTE	145 lm (3000K, 500mA)
FLUSSO EMESSO	103 lm (3000K, 500mA, 25°)
NUMERO E TIPO LED	1 power LED 1/4 ANSI BIN, 50000h L90 B10 (Ta 25°C)
MATERIALE	corpo in alluminio, stelo in ottone
ALIMENTATORE	non incluso, vedi pag. 904
CAVI DI ALIMENTAZIONE	incluso cavo in PVC di 0,50 m FROR 2x0,35 Ø3,5 mm
COLLEGAMENTO	in serie
MONTAGGIO	su superficie (mensola max 30 mm)
ACCESSORI	vedi pag. 639
NOTE	su richiesta disponibile la versione con gestione Casambi, controllabile tramite app Casambi
DATI FOTOMETRICI	vedi pag. 900



Stelo flessibile:
Ø8 mm - 400 mm

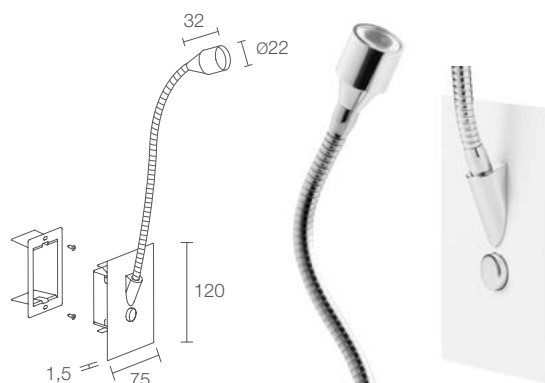

Stelo flessibile:
Ø8 mm - 400 mm

Finitura cromata: piastra bianca
Finitura satinata: piastra satinata

WALL 8.1

CE ENEC LED TECH kg 0,34 IP20

A A+ A++

2,5W 230Vac 400 mm
PL811140 C Cromato
PL811140 S Satinato

3,5W 230Vac 400 mm
PL811240 C Cromato
PL811240 S Satinato

F - 2700K
 5 - 3000K
 9 - 4000K
 0 - 5000K

S - 10°
 M - 25°
 L - 40°

145 lm (3000K, 3,5W)

103 lm (3000K, 25°, 3,5W)

1 power LED
 1/4 ANSI BIN, 50000h L90 B10 (Ta 25°C)

corpo in alluminio, stelo in ottone
 base in acciaio

integrato con interruttore alla base dello stelo

non previsti

tensione di rete

su superficie (parete)

non previsti

su richiesta disponibile la versione con gestione
 Casambi, controllabile tramite app Casambi

vedi pag. 900

WALL 8.2

CE ENEC LED TECH kg 0,37 IP20

A A+ A++

2,5W 230Vac 400 mm
PL821140 C Cromato
PL821140 S Satinato

3,5W 230Vac 400 mm
PL821240 C Cromato
PL821240 S Satinato

F - 2700K
 5 - 3000K
 9 - 4000K
 0 - 5000K

S - 10°
 M - 25°
 L - 40°

145 lm (3000K, 3,5W)

103 lm (3000K, 25°, 3,5W)

1 power LED
 1/4 ANSI BIN, 50000h L90 B10 (Ta 25°C)

corpo in alluminio, stelo in ottone
 piastra in acciaio

integrato con interruttore alla base dello stelo

incluso cavo bipolare di 0,30 m

tensione di rete

su superficie (parete)

vedi pag. 639

su richiesta disponibile la versione con gestione
 Casambi, controllabile tramite app Casambi

vedi pag. 900



Cromato



Satinato





ACCESSORI

ACCESSORI PER INSTALLAZIONE



WC0301

Cassaforma opzionale
(Wall 8.2)

CAVI DI ALIMENTAZIONE

Cavo in PVC
FROR 2x0,35 Ø3,5 mm
lunghezza su richiesta

WF0110

(Wall 8.0)

da ordinare contestualmente all'apparecchio illuminante

WALL

LAMPADE DA LETTURA

WALL 1 3

20° (20°÷55°)

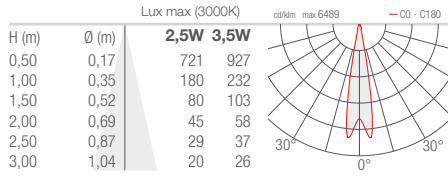

55° (20°÷55°)

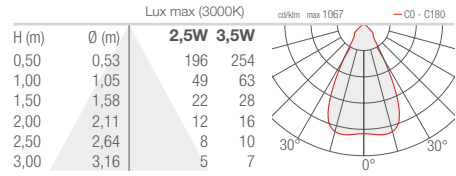

WALL 8.0

S - 10°

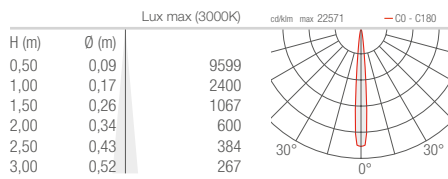

M - 25°

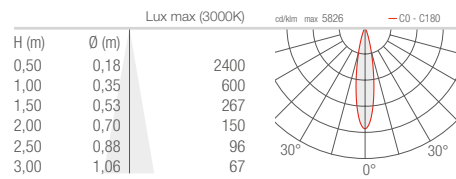

L - 40°

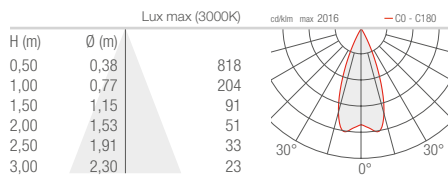

WALL 8.1 8.2

S - 10°

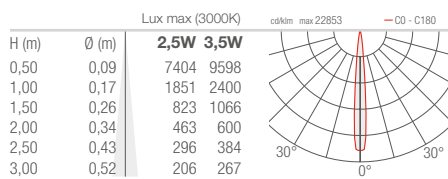

M - 25°

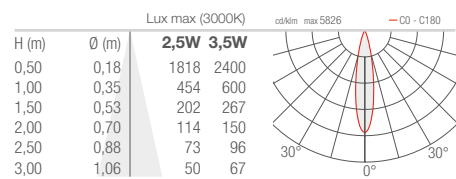

L - 40°

